



Fine grinding and polishing tools











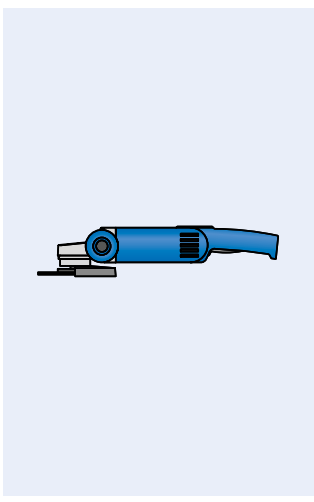

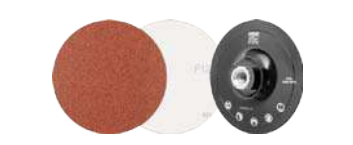

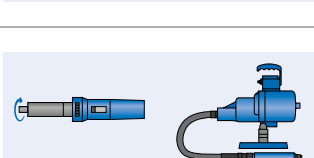
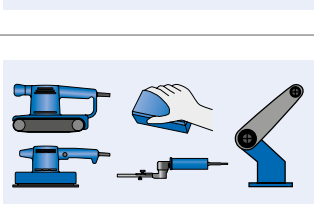

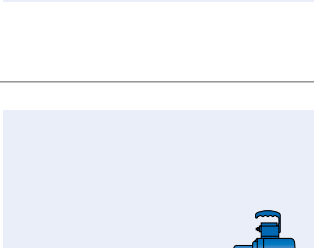

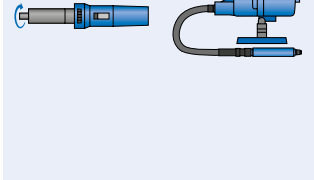



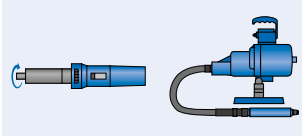

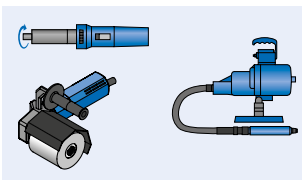
Fine grinding and polishing tools

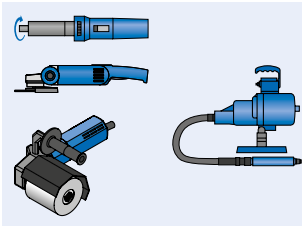
Table of contents

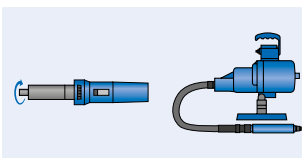
General information	4
The fast way to the best tool	6
Surface roughness – Influencing factors and reference values	8
Coated abrasives	9
Non-woven tools	97

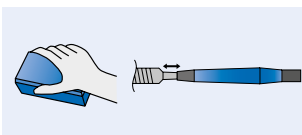
Fine grinding and polishing tools

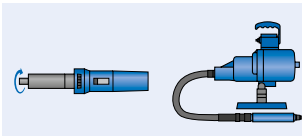
		<p>COMBICLICK</p> <ul style="list-style-type: none"> ■ Fibre discs 12 ■ Non-woven discs 16 ■ Felt discs 18 ■ Backing pads 19 ■ Set 19
		<p>Fibre discs</p> <ul style="list-style-type: none"> ■ Fibre discs 20 ■ Backing pads 24
		<p>Self-adhesive discs</p> <ul style="list-style-type: none"> ■ Self-adhesive discs and holders 25
		<p>Self-adhesive abrasive discs</p> <ul style="list-style-type: none"> ■ Self-adhesive abrasive discs and abrasive disc holders 27
		<p>COMBIDISC grinding tools</p> <ul style="list-style-type: none"> ■ COMBIDISC grinding tools CD, CDR 28
		<p>Flexible abrasives</p> <ul style="list-style-type: none"> ■ Short belts 48 ■ Long belts 52 ■ Abrasive sheets 55 ■ Hand pads 57 ■ Shop rolls and holders 58 ■ Non-woven shop rolls 59 ■ Velcro-backed abrasive discs 61
		<p>Abrasive spiral bands and rubber drum holders</p> <ul style="list-style-type: none"> ■ Abrasive spiral bands KSB 64 ■ Abrasive spiral bands GSB 65 ■ Rubber drum holders 68
		<p>POLIROLL, POLICO</p> <ul style="list-style-type: none"> ■ Cartridge rolls and abrasive cones 69

		POLICAP <ul style="list-style-type: none"> ■ Abrasive caps and abrasive cap holders 	72
		Flap tools <ul style="list-style-type: none"> ■ Mounted flap wheels ■ Unmounted flap wheels ■ Flap drums ■ POLIFLAP tools ■ Overlap slotted discs ■ POLISTAR 	81 86 90 91 93 94
		Non-woven tools <ul style="list-style-type: none"> ■ POLINOX unmounted grinding wheels ■ POLINOX mounted grinding wheels ■ POLINOX cross buffs ■ POLINOX fibre-backing discs ■ POLINOX grinding drums ■ POLINOX discs ■ POLINOX marbling tools ■ POLIVLIES grinding discs ■ POLICLEAN tools 	99, 111 108 110 115 116 118 120 121 123
		Poliflex tools <ul style="list-style-type: none"> ■ PUR bond ■ Structuring tools ■ GR/GHR bond ■ LR/LHR bond ■ TX bond 	130 133 135 138 140
		Ceramic fibre files <ul style="list-style-type: none"> ■ Ceramic fibre files 	143
		Polishing tools <ul style="list-style-type: none"> ■ Felt points ■ Felt wheels ■ Felt sheets ■ Cloth rings 	145 149 150 150
		Grinding oils and polishing pastes <ul style="list-style-type: none"> ■ Grinding and polishing pastes ■ Grinding oils ■ Cleaners 	153 155 156
		Tool sets Tool sets with drives are allocated to the respective tools.	

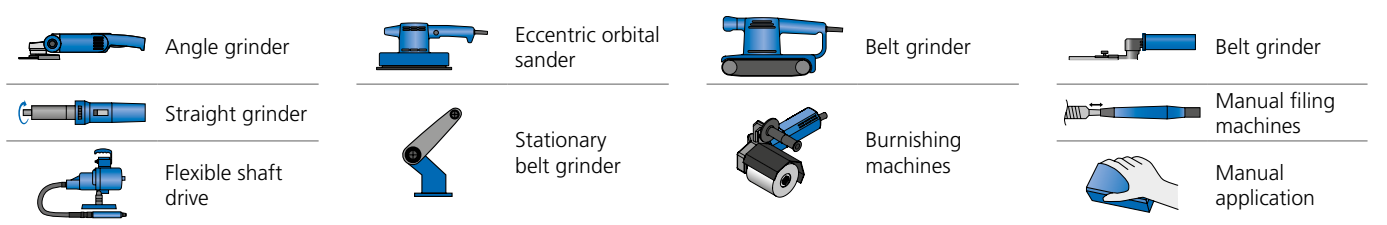

Fine grinding and polishing tools

General information

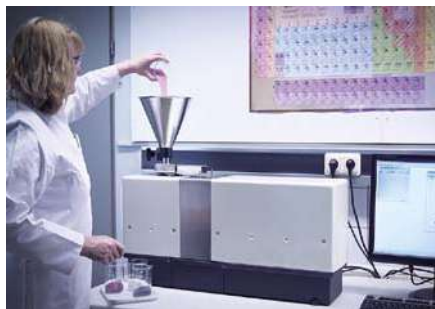

PFERD quality

Fine grinding and polishing tools from PFERD are developed, manufactured and tested in accordance with the strictest quality requirements.

Research and development, our own machine and plant construction, and the continuous testing and further development of the quality and safety standards in our own laboratories all guarantee high PFERD quality.

PFERD quality management is certified according to ISO 9001.



PFERD customer support

If you have any questions regarding the optimization of your grinding work or solutions to specific application problems, our sales representatives and technical advisers will be happy to help.

Just get in touch! Our worldwide sales addresses can be found at: www.pferd.com

Products made to order

If you cannot find the solution for your particular application in our extensive catalogue range, we can produce fine grinding and polishing tools in premium PFERD quality specifically for your application upon request.

We take into account your specifications and wishes, drawings, information on dimensions and shapes, grit sizes and grain types, grain mixtures, in addition to shank diameters and lengths. Please speak to our sales representatives. We will be happy to advise you.



PFERD packaging

PFERD supplies fine grinding and polishing tools in robust industrial packaging, which protects the tools against damage. You can find details on the packaging unit (PU) in the product tables. Important information such as the item number, description, EAN code, technical specifications and safety notes can be found on the packaging label.



PFERD TOOL-CENTER

You will also find all the important information you require in order to select the most appropriate tool at your local specialist retailer's **PFERD TOOL-CENTER**. The information and theme cards from PFERD provide you with useful tips on tools and applications.

Your local retailer or PFERD sales representative will be glad to answer any questions you might have.



PFERD PRAXIS brochures and theme brochures

Our PFERD PRAXIS brochures, theme brochures and FOCUS brochures contain a wealth of useful information on material properties, as well as tips and tricks for using PFERD tools.



PFERDVALUE – Your added value with PFERD

Results from the PFERD test laboratories as well as from the product tests by independent testing institutes prove: PFERD tools offer measurable added value.

Discover **PFERDERGONOMICS** and **PFERDEFFICIENCY**:

As part of **PFERDERGONOMICS**, PFERD offers ergonomically optimized tools and tool drives that contribute to greater safety and working comfort, and thus to health protection.



As part of **PFERDEFFICIENCY**, PFERD offers innovative, high-performance tool solutions and tool drives with outstanding added value.



For more information on this topic, please refer to our brochure "PFERDVALUE – Your added value with PFERD".

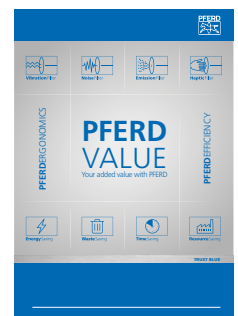

All tools and more information:
www.pferd.com



Fine grinding and polishing tools

The fast way to the best tool

Work type	Face-down grinding Tools with backing pad		Belt grinding Tools for belt grinders			
	Work steps	Page	Page	Page		
Changing geometrical profiles 	 COMBIDISC ■ abrasive discs 31–38 ■ diamond abrasive discs 37		 Self-adhesive discs 25–26		 Short belts 48–51	
	 COMBIDISC midget fibre discs 35–36		 Fibre discs 21–24		 Long belts 52–54	
	 COMBIDISC Mini-POLIFAN 30		 COMBICLICK fibre discs 13–15			
Step-by-step fine grinding Reducing roughness depths 	 COMBIDISC ■ abrasive discs 31–38 ■ non-woven discs 39–41		 Self-adhesive discs 25–26		 Short belts 48–51	
	 Poliflex discs 131		 PSA discs 27		 Long belts 52–54	
	 COMBICLICK non-woven discs 16–17		 Velcro-backed abrasive discs 61–62			
	 POLINOX unitized discs 102		 Fibre discs 21–24			
	 POLINOX-discs PNL/PNZ 115		 COMBICLICK fibre discs 13–15			
Fine grinding Very fine grinding 	 Grinding oils 155		 Fibre discs 21–24		 Grinding oils 155	
	 COMBIDISC ■ abrasive discs 31–38 ■ non-woven discs 39–41		 PSA discs 27		 Short belts 48–51	
	 Poliflex discs 131		 COMBICLICK fibre discs 13–15		 Long belts 52–54	
	 POLINOX unitized discs 102				 Short belts, non-woven 50	
Cleaning 	 COMBIDISC non-woven discs 39–41		 POLIVLIES self-adhesive discs 122		 Short belts, non-woven 50	
	 COMBIDISC POLICLEAN discs 38		 POLICLEAN discs 125			
	 COMBICLICK non-woven discs 16–17					
Creating visual effects 	 COMBIDISC non-woven discs 39–41		 POLIVLIES self-adhesive discs 122		 Short belts, non-woven 50	
	 COMBIDISC TX discs 42		 Marbling tools 120, 132			
	 POLIVLIES flap discs 121		 Poliflex structuring tools 133–134			
	 POLINOX discs PNL/PNZ 115		 COMBICLICK non-woven discs 16–17			
Polishing 	 COMBIDISC felt discs 42		 Felt flap wheels 149		 Short belts, felt 51	
	 COMBICLICK felt discs 18					

Peripheral grinding Mounted tools, tools with arbor holes			Manual grinding		
					
	Page			Page	
	Abrasive spiral bands	64–67		Overlap slotted discs	93
	POLIROLL, POLICO	70–71			
	POLICAP	74–80			
	Abrasive spiral bands	64–67		Unmounted flap wheels for angle grinders	89
	POLIROLL	70–71		Flap drums	90
	POLICAP	74–80		POLISTAR	94–95
	Mounted flap wheels	83–85		Overlap slotted discs	93
	Unmounted flap wheels	87–88			
	POLIROLL, POLICO	70–71		Poliflex fine grinding wheels	131, 137, 142
	Grinding oils	155		POLINOX unitized wheels	101, 106
	Poliflex fine grinding points	130, 135–136, 138–141			
				Poliflex blocks	132
				Ceramic fibre files	143
				Abrasive sheets, cloth/paper	55–56
				Shop rolls, cloth/paper	58–59
				Poliflex blocks	132
				Diamond hand pads	57
				Abrasive sheets, cloth/paper	55–56
				Shop rolls, cloth/paper	58–59
	POLINOX mounted grinding wheels	108–109		POLINOX grinding drums	116–117
	POLINOX unmounted grinding wheels	111–113		POLICLEAN wheels	124
	POLINOX cross buffs	110		POLICLEAN mounted tools	125
	POLINOX mounted grinding wheels	108–109		POLIFLAP grinding wheel	91
	POLINOX unmounted grinding wheels	111–113		Poliflex structuring tools	133–134
	POLINOX grinding drums	116–117		Flap drums	90
	POLINOX discs	118			
	Felt points	145–148		Mounted felt flap wheels	148
	Felt wheels and lenses	149		Cloth rings	150–151
				Diamond polishing pastes	154
				Grinding pastes	153
				Polishing paste bars	153

Fine grinding and polishing tools

Surface roughness – influencing factors and reference values

Factors influencing surface roughness:

Abrasive:

- The larger the grit, the rougher the surface finish will be.
- Aluminium oxide, ceramic oxide grain and zirconia alumina achieve similar levels of surface roughness.
- Workpieces which are machined with silicon carbide exhibit a slightly finer surface finish.

Material to be worked:

- The softer the material to be machined, the coarser the finished surface will be when using the same grit sizes.
- Adding grease or lubricant will achieve a slightly finer surface finish.

Work parameters:

- The relationship between the cutting speed and feed rate has the following impact:
 - Increasing the cutting speed slightly improves the surface quality.
 - Reducing the speed of the feed rate makes the surface quality slightly finer.
- The contact pressure only has a minor influence on the surface roughness.

There is a differentiation between the following roughness depths:

The **individual roughness depth R_{zi}** is the sum of the height of the largest profile peak and the depth of the largest profile trough within an individual measuring section.

The **roughness depth R_z** is the mean value of the individual roughness depths (R_{zi}) of consecutive individual measuring sections.

The **roughness depth R_{max}** is the largest individual roughness depth within the overall measuring section.

The **average roughness value R_a** is the arithmetic mean value of the sum of all profile values within the roughness profile.

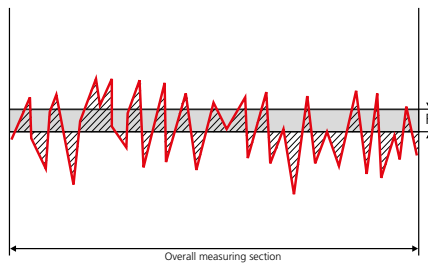
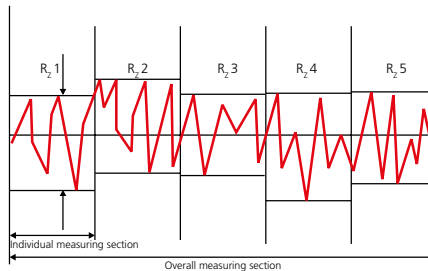

Reference values for roughness depths in the case of different applications

Application	Roughness depth
Coarse grinding: Grit sizes 24 to 150	$R_a = 0.70$ to $12 \mu\text{m}$
Fine grinding: Grit sizes 180 to 400	$R_a = 0.20$ to $0.70 \mu\text{m}$
Very fine grinding: Grit sizes 500 to 1,200	$R_a = 0.05$ to $0.20 \mu\text{m}$
Polishing: Step 1: Step 2: Step 3:	$R_a = 0.10$ to $0.20 \mu\text{m}$ $R_a = 0.04$ to $0.10 \mu\text{m}$ $R_a < 0.01 \mu\text{m}$
Structuring: Surfaces ground	$R_a = 0.20$ to $0.70 \mu\text{m}$
Satinizing/ matt finishing: With non-woven abrasive	$R_a = 0.10$ to $0.70 \mu\text{m}$

Surface roughness of different materials after machining with tools using coated abrasives

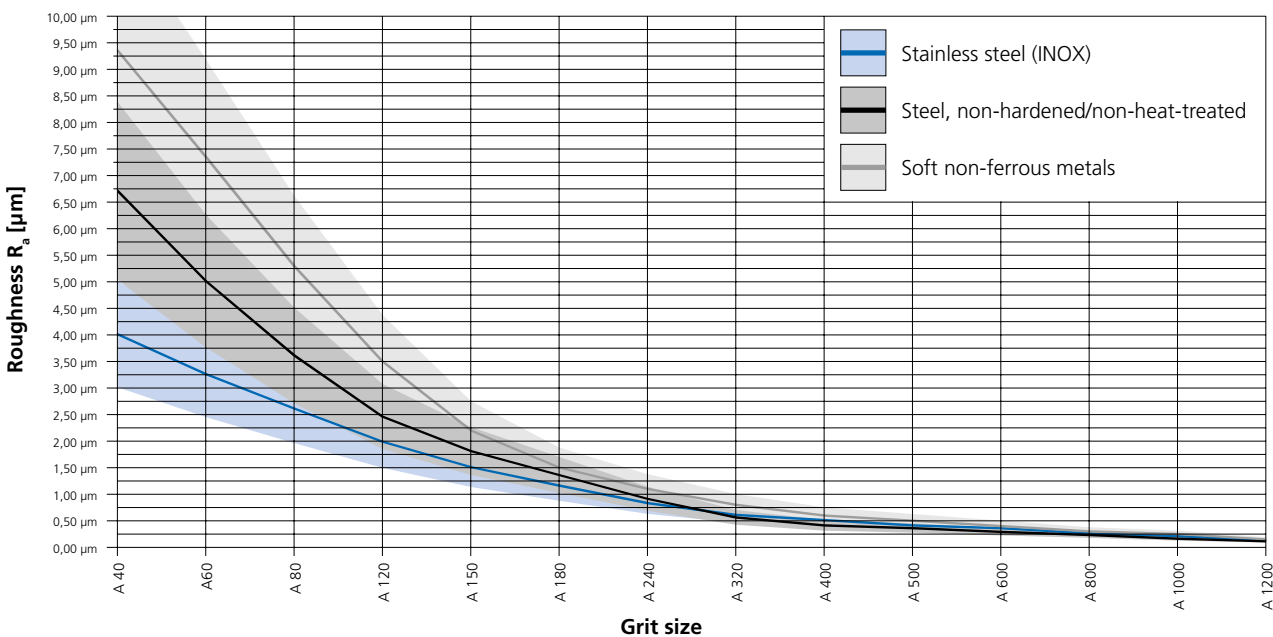

Structure of coated abrasives

PFERD supplies a wide range of tools with coated abrasives for machining a variety of workpiece geometries and materials:

- COMBICLICK fibre discs
- Fibre discs
- COMBIDISC abrasive discs
- Abrasive spiral bands and abrasive belts
- Mounted and unmounted flap wheels
- Abrasive sheets and shop rolls
- POLIROLL cartridge rolls and POLICO abrasive cones
- Velcro-backed abrasive discs
- Self-adhesive abrasive discs (PSA)

You can find additional PFERD tools with coated abrasives in catalogue section 6.

Coated abrasives are used for both wet and dry grinding.

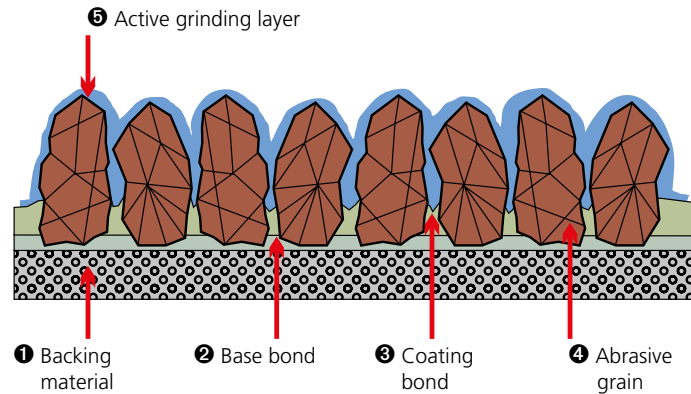

① Backing material

Bond and abrasive grain are applied to the base. The backing materials available for selection differ in their properties, such as tear strength, flexibility and wear. The respective grinding tool is adapted to the requirements of the intended application by choosing the appropriate base material. The PFERD range is sub-divided into three groups:

Paper:

The main areas of application for coated abrasives with a paper base are in the woodworking industry and in trade, e.g. among carpenters, painters and decorators. Coated abrasives with a paper base are rarely used for industrial metalwork. Abrasives for manual grinding are predominantly made from paper with a surface weight of 70 to 100 g/m². Heavier paper types are used to make abrasives for machine applications involving wide and narrow belts alike.

Cloth:

Coated abrasives with a cloth base are predominantly used for metalwork.

Vulcanized fibre:

When adapted to the corresponding applications, vulcanized fibre in various thicknesses is predominantly used for making fibre grinding discs. Vulcanized fibre is a very sturdy, robust backing material, and also very wear-resistant.

② + ③ Bond



When manufacturing coated abrasives, different resin bonds are used to fix the abrasive grain to the backing material. First, the backing material is coated with the base bond (②). After this, the abrasive grain is evenly scattered over the surface and aligned to achieve higher aggressiveness with the help of special procedures. The coating bond (③) ensures that the abrasive grain is fixed in place and protects the grain against the forces and loads resulting from the grinding process.



④ Abrasive grain

Choosing the right abrasive grain has a significant influence on surface quality and profitability.

The most common materials for abrasive grain are:

Aluminium oxide A		<p>Numerous types of aluminium oxide are used as abrasives. These may be present in molten or sintered form. The hardness and toughness can be influenced by special manufacturing procedures or additives. Standard types of aluminium oxide and a "sharp-edged" grain shape are predominantly used for coated abrasives.</p>
Ceramic oxide grain CO		<p>For sintered aluminium oxides, a differentiation is made between sintered bauxite aluminium oxides and sol-gel aluminium oxides. Sol-gel aluminium oxides are predominantly used for coated abrasives in the form of abrasive ceramic grain. This state-of-the-art abrasive is used for numerous applications thanks to its high toughness and good self-sharpening qualities.</p>
Zirconia alumina Z		<p>Zirconia alumina is a fused mixture of aluminium oxide and zirconium oxide. In comparison to aluminium oxides, zirconia alumina exhibits lower hardness but greater toughness. The high proportion of zirconium oxide results in an extremely powerful self-sharpening effect and contributes to outstanding stock removal rates with cool grinding and a long tool life.</p>
Silicon carbide SiC		<p>Silicon carbide is synthetically manufactured abrasive grain which is very sharp-edged, with low toughness and very high hardness. It is particularly suitable for work on titanium, aluminium, bronze, stone and plastics. Ideally suited for use in the aeronautical industry, especially where SiC is the only approved abrasive, e.g. for use on engine components.</p>
Diamond grain D		<p>Diamond grain is the hardest abrasive. It consists of pure carbon in a crystalline structure. For grinding tools, the diamonds used are generally synthetic, produced at very high temperatures and under high pressure. The properties of diamond grain can be adapted for use in grinding tools through various synthesis conditions.</p>
Compact grain CK		<p>In the case of compact grain, individual grains are built up as granulate with a bond system. Each individual grain of granulate is one solid unit, in which numerous abrasive grains made from aluminium oxide or silicon carbide (SiC) are joined together. Used abrasive grains are torn out of this compound structure by the forces resulting from the grinding, and expose sharp abrasive points in doing so. This guarantees a long tool life with a constant surface quality.</p>
VICTOGRAIN 		<p>VICTOGRAIN products are some of the most effective grinding tools in the world. PFERD's triangular, precision-formed abrasive grain achieves uniquely high abrasive performance.</p> <p>The VICTOGRAIN abrasive grain triangles are identical in shape and size and their cutting edges are applied to the workpiece at the optimum angle, meaning the grain needs very little energy to penetrate the workpiece. As such, the user benefits from an efficient machining process with fast working, a long tool life, less heat build-up in the workpiece, and a lower power output required for the tool drive.</p> <p>The VICTOGRAIN abrasive grain triangles are fixed to the substrate on one of their sides. This means they are securely fixed in place and, together with their slim design, offer an extremely large chip space in order to further improve machining efficiency.</p> <p>The structure of the triangular VICTOGRAIN has also been specially adapted to maximize results. The very small crystals inside the triangles ensure optimal wear characteristics as sharp cutting edges are always exposed, but only the minimum amount of abrasive grain/the triangle breaks off.</p> <p>By combining all these properties together, users benefit from optimal, constant performance during cool grinding and an extremely long tool life together with consistent workpiece surface roughness.</p>

Grit sizes

The various grit sizes for coated abrasives are specified in ISO 6344 and have been adopted for FEPA standards:

Coarse	Medium	Fine	Superfine
P 12 – 16 – 20 – 24 – 36 – 40 – 50 – 60 – 80	P 100 – 120 – 150 – 180 – 220 – 240 – 280	P 320 – 360 – 400 – 500 – 600	P 800 – 1000 – 1200 – 1500

⑤ Active grinding layer

The use of an active grinding layer considerably increases the stock removal rate and reduces the workpiece temperature.

This is especially advantageous for materials with poor heat-conducting properties, such as stainless steel (INOX).

PFERD tools with an active grinding layer feature the additional "COOL" label in their item description.

The patented quick-mounting and cooling system from PFERD is suitable for use with fibre, non-woven and felt discs.

The COMBICLICK system consists of a specially developed backing pad and a rugged mounting system at the back of the tool. With the backing pad, COMBICLICK tools can be used on commercially available angle grinders.

The special geometry of the cooling slots ensures high air throughput, which in turn considerably reduces the thermal load on the abrasive material and the workpiece.

Compared to conventional tools, the quick-mounting system, the robust holder, the safe fixing of the tool and the integrated cooling system together achieve a workpiece temperature that is 30 % lower, a stock removal rate that is 25 % higher, a tool life that is 30 % longer and better exploitation of the abrasive material.

Lower process costs and workpiece temperature

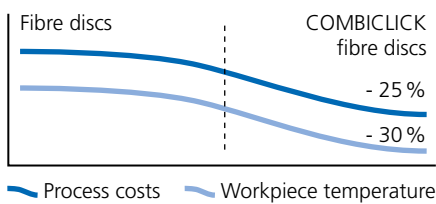

Higher stock removal rate

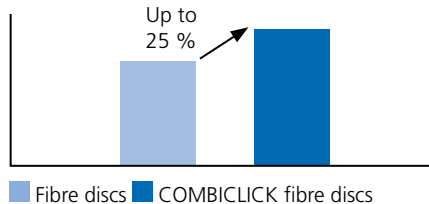

Longer tool life

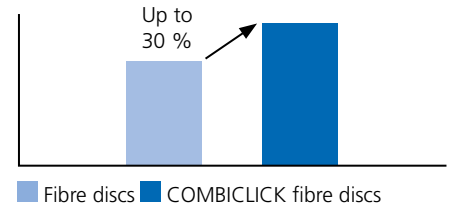

Advantages:

System



Very easy and convenient handling.

Clamping



Extremely fast and simple tool changing reduces process costs.

Cooling effect



Very good cooling of the tool and workpiece.

Flexible grinding

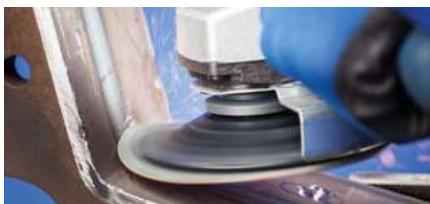

Particularly soft and flexible grinding properties for face-down grinding with fibre discs of diameter 125 mm.

A very low angle to the workpiece is possible with COMBICLICK!



Using COMBICLICK helps to avoid scratches caused by protruding clamping pieces, and exploits the abrasive material that is available.



PFERDVALUE:

PFERDERGONOMICS recommends COMBICLICK as an innovative tool solution to sustainably reduce vibration, noise and dust levels produced by tools, and to improve working comfort.

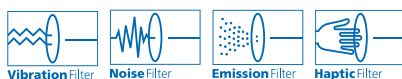

PFERDEFFICIENCY recommends COMBICLICK for long, fatigue-free and resource-saving work, with perfect results in the shortest possible time. The patented quick-mounting system reduces tool change and setup times.



The wide range of COMBICLICK fibre discs offers the best tool for any grinding application, from coarse to fine.

Advantages:

- Innovative quick-mounting system guarantees convenient handling and cool grinding.
- High profitability thanks to long tool life and very high stock removal rate.
- Consistent surface finish thanks to high-quality abrasives.

Applications:

- Levelling
- Deburring
- Surface work
- Work on edges
- Work on weld seams
- Step-by-step fine grinding

Recommendations for use:

- Use COMBICLICK fibre discs with COMBICLICK backing pads on commercially available angle grinders.
- Use grinding oil which is suitable for the material in order to considerably increase the tool life and abrasive performance of the tools. More detailed information and ordering data for grinding oils can be found on page 155.
- For particularly flexible performance when face-down grinding, use fibre discs with a diameter of 125 mm.

Matching tool drives:

- Angle grinders
- Cordless angle grinders

Ordering notes:

- Please order COMBICLICK backing pads separately. More detailed information and ordering data for backing pads can be found on page 19.
- When ordering, please state the EAN or the full description.
- **Ordering example:**
EAN 4007220722275
CC-FS 125 A-COOL 60
- **Ordering example explanation:**
CC-FS = COMBICLICK fibre disc
125 = Outer diameter D [mm]
A = Abrasive
COOL = Bond type
60 = Grit size

Safety notes:

- The maximum permitted peripheral speed is 80 m/s.
- For safety reasons, the specified maximum permitted rotational speed must never be exceeded.



Accessories:

- COMBICLICK backing pads

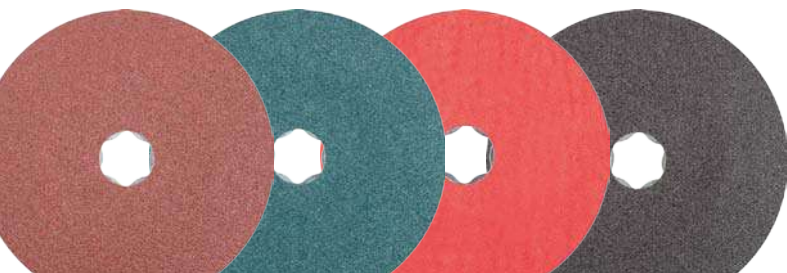

The fast way to the best tool

Material group ▼		Abrasive ►	Aluminium oxide A	Zirconia Alumina Z	Ceramic oxide grain CO	VICTO-GRAIN COOL	Silicon carbide SiC	Aluminium oxide A-COOL	Ceramic oxide grain CO-COOL
Steel, cast steel	Non-hardened, non-heat-treated steels	Construction steels, carbon steels, tool steels, non-alloyed steels, cast steel	●	○	●	●			
	Hardened, heat-treated steels	Tool steels, tempering steels, alloyed steels, cast steel	○	●	●	●			
Stainless steel (INOX)	Rust- and acid-resistant steels	Austenitic and ferritic stainless steels		○		●		●	●
Non-ferrous metals	Soft non-ferrous metals, non-ferrous metals	Soft aluminium alloys	○					●	○
		Brass, copper, zinc	●	○	○				
	Hard non-ferrous metals	Hard aluminium alloys	●	○	○		○		
		Bronze, titanium		○	○	●	●		●
	High-temperature-resistant materials	Nickel-based and cobalt-based alloys		○	○	●			●
Cast iron	Grey cast iron, white cast iron	Cast iron with flake graphite EN-GJL (GG), with nodular graphite/nodular cast iron EN-GJS (GGG), white annealed cast iron EN-GJMW (GTW), black cast iron EN-GJMB (GTS)	●	○	●				
Plastics, other materials		Fibre-reinforced plastics, thermoplastics, wood, chipboard, paintwork	●				●		

● = Highly suitable

○ = Suitable

Aluminium oxide A type

For universal grinding work from coarse to fine grinding in industry and professional trades.

Abrasive:

Aluminium oxide A

Ordering notes:

- Please complete the description with the desired grit size.

PFERDVALUE:

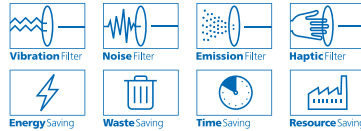

D [mm]	Grit size						Max. RPM		Description
	24	36	50	60	80	120			
	EAN 4007220								
100	-	836095	836101	836118	836125	836132	15,300	25	CC-FS 100 A ...
115	763179	763186	763193	763209	763216	763223	13,300	25	CC-FS 115 A ...
125	721988	721995	722008	722039	722060	722077	12,200	25	CC-FS 125 A ...

Zirconia alumina Z type

For coarse grinding work with a high stock removal rate and a long tool life.

Abrasive:

Zirconia alumina Z

Recommendations for use:

- Use powerful angle grinders in the case of a higher contact pressure.

Ordering notes:

- Please complete the description with the desired grit size.

PFERDVALUE:

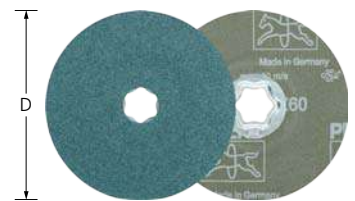
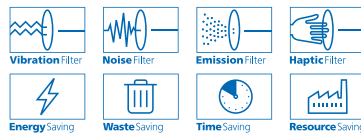

D [mm]	Grit size						Max. RPM		Description
	24	36	50	60	80	120			
	EAN 4007220								
115	-	722572	722596	763230	722619	722633	13,300	25	CC-FS 115 Z ...
125	722640	722657	722664	722671	722688	722695	12,200	25	CC-FS 125 Z ...

Ceramic oxide grain CO type

For aggressive grinding with a very high stock removal rate and very long tool life. The ceramic oxide grain is specifically designed for work on hard materials and layers.

Abrasive:

Ceramic oxide grain CO

Recommendations for use:

- Use powerful angle grinders.

Ordering notes:

- Please complete the description with the desired grit size.

PFERDVALUE:

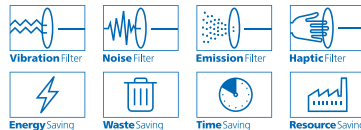

D [mm]	Grit size						Max. RPM		Description
	24	36	50	60	80	120			
	EAN 4007220								
115	763247	763254	763261	763278	763285	763292	13,300	25	CC-FS 115 CO ...
125	722084	722169	722183	722206	722237	722268	12,200	25	CC-FS 125 CO ...



Silicon carbide SiC type

For universal grinding work on components made from aluminium, copper, bronze, titanium and fibre-reinforced plastics.

Particularly recommended for use on titanium alloys.

Ideally suited to use in the aeronautical industry, especially where SiC is the only approved abrasive, e.g. for use on engine components.

Abrasive:
Silicon carbide SiC

Ordering notes:

- Please complete the description with the desired grit size.

PFERDVALUE:

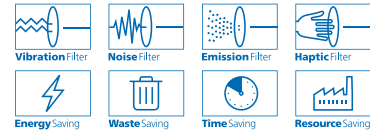

D [mm]	Grit size				Max. RPM		Description
	36	60	80	120			
EAN 4007220							
115	898888	898895	898901	898918	13,300	25	CC-FS 115 SiC ...
125	898925	898932	898949	898956	12,200	25	CC-FS 125 SiC ...

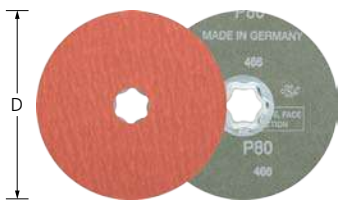

Aluminium oxide A-COOL type

For universal grinding work from fine to very fine grinding on materials which do not conduct heat well, e.g. stainless steel (INOX) and aluminium.

Active grinding additives in the coating substantially improve the stock removal rate, prevent clogging and result in cooler grinding.

Abrasive:
Aluminium oxide A-COOL

Ordering notes:

- Please complete the description with the desired grit size.

PFERDVALUE:

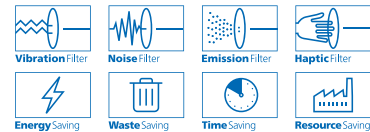

D [mm]	Grit size						Max. RPM		Description	
	50	60	80	120	150	180				220
EAN 4007220										
115	-	722176	722190	722213	722220	-	722244	13,300	25	CC-FS 115 A-COOL ...
125	722251	722275	722299	722312	722329	722343	722367	12,200	25	CC-FS 125 A-COOL ...

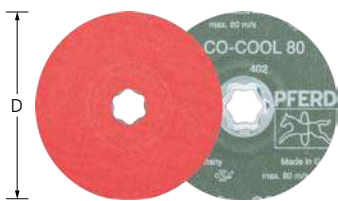

Ceramic oxide grain CO-COOL type

For aggressive grinding with maximum stock removal rate on hard materials which do not conduct heat well. Consistently high performance due to self-sharpening ceramic oxide grain.

Active grinding additives in the coating substantially improve the stock removal rate, prevent clogging and result in cooler grinding.

Abrasive:
Ceramic oxide grain CO-COOL

Ordering notes:

- Please complete the description with the desired grit size.

PFERDVALUE:

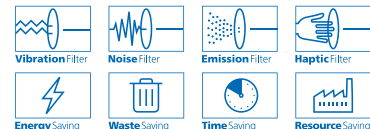

D [mm]	Grit size						Max. RPM		Description
	24	36	50	60	80	120			
EAN 4007220									
100	-	836149	836163	836187	836194	892442	15,300	25	CC-FS 100 CO-COOL ...
115	763308	763315	763322	763339	763346	763353	13,300	25	CC-FS 115 CO-COOL ...
125	722442	722473	722480	722497	722503	722510	12,200	25	CC-FS 125 CO-COOL ...
180	722534	722558	722565	722589	722602	-	8,500	25	CC-FS 180 CO-COOL ...

VICTOGRAIN-COOL type

For extremely aggressive grinding with an extremely long tool life and an outstanding stock removal rate on steels and materials which are hard or have poor heat-conducting properties.

Outstanding, constant high performance thanks to the **VICTOGRAIN** abrasive grain.

Active grinding additives in the coating substantially improve the stock removal rate, prevent clogging and result in cooler grinding.

Abrasive:
VICTOGRAIN-COOL

Recommendations for use:

- Use powerful angle grinders.

PFERDVALUE:

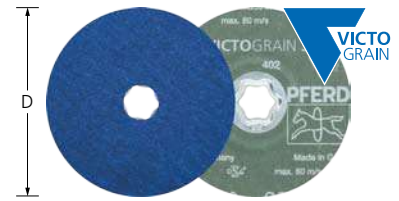
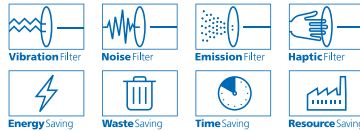

D [mm]	EAN 4007220	Max. RPM		Description
100	109267	15,300	25	CC-FS 100 VICTOGRAIN-COOL 36
115	109250	13,300	25	CC-FS 115 VICTOGRAIN-COOL 36
125	109274	12,200	25	CC-FS 125 VICTOGRAIN-COOL 36
180	109281	8,500	25	CC-FS 180 VICTOGRAIN-COOL 36

High-performance tools with VICTOGRAIN abrasive grain

VICTOGRAIN products are some of the most effective grinding tools in the world. PFERD's triangular, precision-formed abrasive grain achieves uniquely high abrasive performance.

The **VICTOGRAIN** abrasive grain triangles are identical in shape and size and their cutting edges are applied to the workpiece at the optimum angle, meaning the grain needs very little energy to penetrate the workpiece. As such, the user benefits from an efficient machining process with

- fast working,
- a long tool life,
- less heat build-up in the workpiece, and
- a lower power output required for the tool drive.

The **VICTOGRAIN** abrasive grain triangles are fixed to the substrate on one of their sides. This means they are securely fixed in place and, together with their slim design, offer an extremely large chip space in order to further improve machining efficiency.

The structure of the triangular **VICTOGRAIN** has also been specially adapted to maximize results. The very small crystals inside the triangles ensure optimal wear characteristics as sharp cutting edges are always exposed, but only the minimum amount of abrasive grain/the triangle breaks off.

By combining all these properties together, users benefit from optimal, constant performance during cool grinding and an extremely long tool life together with consistent workpiece surface roughness.

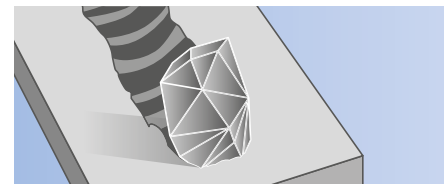

Conventional abrasive grain

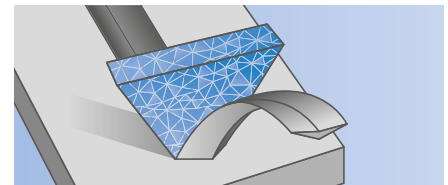

VICTOGRAIN abrasive grain



The **VICTOGRAIN** abrasive grain is optimally aligned

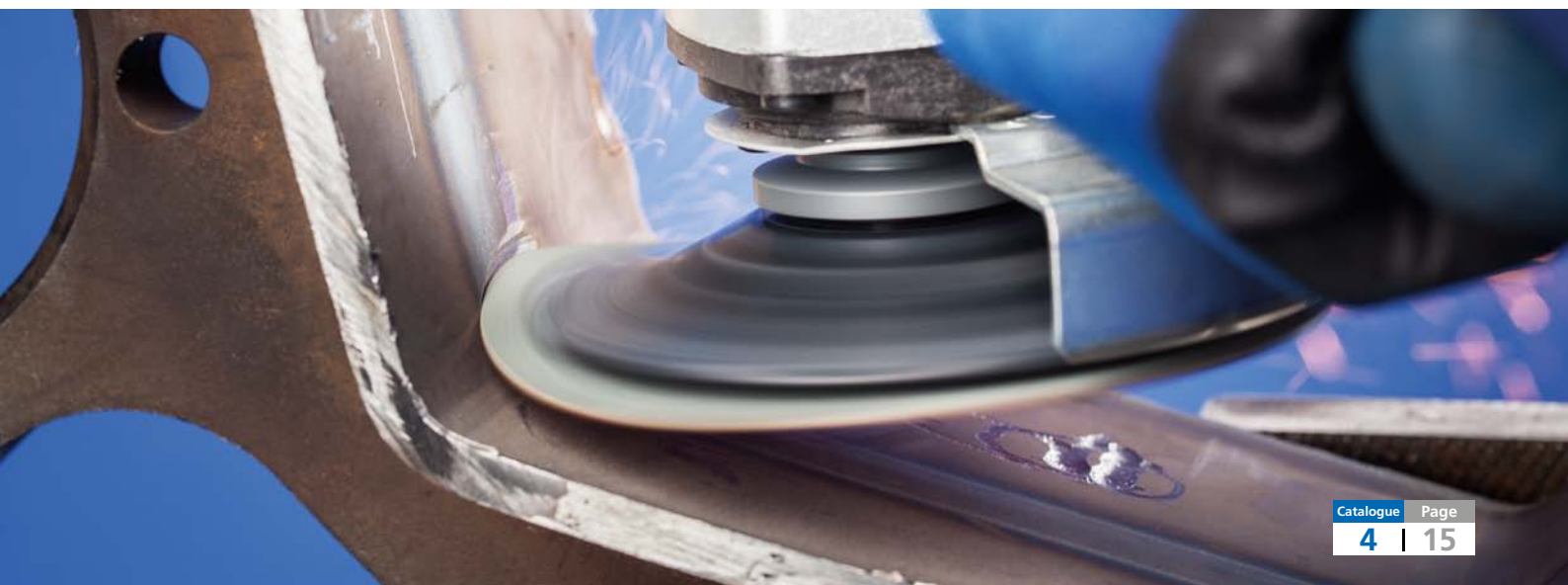

COMBICLICK

General information – Non-woven discs



COMBICLICK non-woven discs are used for face-down grinding. They are available in the following types: VRW (soft), VRH (hard) and PNER.

Advantages:

- Innovative quick-mounting system guarantees convenient handling and cool grinding.

Materials that can be worked:

- Can be used on nearly all materials.

Applications:

- Roughening
- Deburring
- Surface work
- Cleaning
- Work on weld seams
- Structuring surfaces
- Step-by-step fine grinding

Recommendations for use:

- Use COMBICLICK non-woven discs with COMBICLICK backing pads on speed-adjustable angle grinders.

Matching tool drives:

- Angle grinders
- Cordless angle grinders

Ordering notes:

- Please order COMBICLICK backing pads separately. More detailed information and ordering data for backing pads can be found on page 19.
- When ordering, please state the EAN or the full description.

Ordering example:

EAN 4007220**935873**
CC-VRH 115 A **180 M**

Ordering example explanation:

CC-VRH = COMBICLICK non-woven discs, hard type
115 = Outer diameter D [mm]
A = Abrasive
180 M = Grit size

Safety notes:

- For safety reasons, the specified maximum permitted rotational speed must never be exceeded.



Accessories:

- COMBICLICK backing pads



Non-woven discs

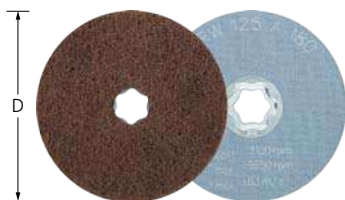

Soft type CC-VRW

Suitable for very fine grinding on moderate and coarse surfaces and contours, and for cleaning metal and painted surfaces. Achieve matt and satin-finished surfaces. Highly open structure.

Advantages:

- Can be used for wet and dry working.
- The open structure and high flexibility of the non-woven material prevents tool clogging.

Abrasive:

Aluminium oxide A

Available POLINOX grit sizes:

100 = medium
180 = fine
280 = very fine

Recommendations for use:

- For the best results, use at a recommended cutting speed of 15–20 m/s. This provides an ideal compromise between stock removal rate, surface quality, thermal load on the workpiece and tool wear.

Ordering notes:

- Please complete the description with the desired grit size.

PFERDVALUE:

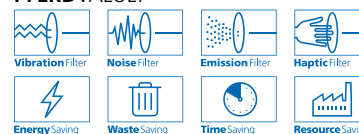

D [mm]	Grit size			Opt. RPM	Max. RPM		Description
	100	180	280				
	EAN 4007220						
100	948170	948163	948156	3,800	12,000	10	CC-VRW 100 A ...
115	935941	935934	935927	3,300	10,500	10	CC-VRW 115 A ...
125	935972	935965	935958	3,100	9,650	10	CC-VRW 125 A ...

Hard type CC-VRH

Suitable for universal work on moderate and coarse metal surfaces, e.g. removal of rough grinding traces, removal of oxidation and light deburring work. Achieve matt and satin-finished surfaces.

Advantages:

- Little wear due to high tear strength.
- The open structure of the non-woven material prevents tool clogging.

Abrasive:

Aluminium oxide A
Available POLIVLIES grit sizes:
100 G = coarse (yellow-brown)
180 M = medium (red-brown)
240 F = fine (blue)

Recommendations for use:

- For the best results, use at a recommended cutting speed of 15–20 m/s. This provides an ideal compromise between stock removal rate, surface quality, thermal load on the workpiece and tool wear.

- The addition of oil or water during grinding results in a finer finish, cooler grinding and longer tool life.

Ordering notes:

- Please complete the description with the desired grit size.

PFERDVALUE:

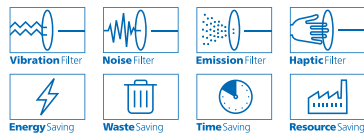

D [mm]	Grit size			Opt. RPM	Max. RPM	Box icon	Description
	100 G	180 M	240 F				
	EAN 4007220						
100	948149	948132	948125	3,800	12,000	10	CC-VRH 100 A ...
115	935880	935873	935743	3,300	10,500	10	CC-VRH 115 A ...
125	935910	935903	935897	3,100	9,650	10	CC-VRH 125 A ...

CC-PNER type

For achieving a very fine, uniform surface finish which, depending on requirements, is a sufficient preparation for high-gloss polishing. Especially suitable for work on larger surfaces on components made of stainless steel (INOX).

The different thicknesses/hardnesses of the non-woven material are colour-coded:

W (soft) = grey, MW (medium-soft) = light blue, MH (medium-hard) = dark blue, H (hard) = red

Advantages:

- High edge strength thanks to extreme durability.
- Can be profiled as desired, enabling optimal adjustment to the contour.

Abrasive:

Aluminium oxide A
Silicon carbide SiC

Recommendations for use:

- For the best results, use at a recommended cutting speed of 15–35 m/s. This provides an ideal compromise between stock removal rate, surface quality, thermal load on the workpiece and tool wear.

Ordering notes:

- Please complete the description with the desired type.
- Further information on PNER type non-woven products can be found on pages 99–100.

PFERDVALUE:

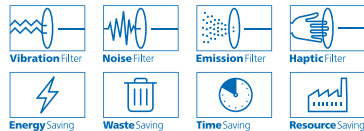

D [mm]	Abrasives	Type				Grit size	Opt. RPM	Max. RPM	Box icon	Description
		W (soft)	MW (medium-soft)	MH (medium-hard)	H (hard)					
		EAN 4007220								
100	SiC	948187	948194	948200	-	fine	5,700	9,550	5	CC-PNER ... 100 SiC F
	A	-	-	-	948217	fine	5,700	9,550	5	CC-PNER ... 100 A F
115	SiC	935989	936009	936016	-	fine	5,000	8,350	5	CC-PNER ... 115 SiC F
	A	-	-	-	936023	fine	5,000	8,350	5	CC-PNER ... 115 A F
125	SiC	935996	936030	936047	-	fine	4,500	7,650	5	CC-PNER ... 125 SiC F
	A	-	-	-	936054	fine	4,500	7,650	5	CC-PNER ... 125 A F

COMBICLICK

General information – Felt discs

COMBICLICK felt discs are used for face-down grinding on medium-sized and large surfaces. They are supplied in various diameters.

Advantages:

- Innovative quick-mounting system guarantees convenient handling with fast tool changes.

Materials that can be worked:

- Can be used on nearly all materials.

Applications:

- Polishing

Recommendations for use:

- Use COMBICLICK felt discs with COMBICLICK backing pads on speed-adjustable angle grinders.
- For best performance, use with a recommended cutting speed of 5–10 m/s. This provides an ideal compromise between polishing performance, thermal load on the workpiece and tool wear.
- When changing the polishing paste, use a brand-new felt disc.

Matching tool drives:

- Angle grinders
- Cordless angle grinders

Ordering notes:

- Please order COMBICLICK backing pads separately. More detailed information and ordering data for backing pads can be found on page 19.
- Please order grinding and polishing pastes separately. Detailed information and ordering data for grinding and polishing pastes can be found on pages 153–155.

Safety notes:

- For safety reasons, the specified maximum permitted rotational speed must never be exceeded.



Accessories:

- COMBICLICK backing pads
- Grinding and polishing pastes



Felt discs CC-FR



CC-FR type

Suitable for polishing with polishing paste bars, grinding pastes or diamond polishing pastes in face-down grinding on medium-sized and large surfaces.

Advantages:

- High economic efficiency due to very long tool life.
- Focused working over the entire lifespan thanks to high dimensional stability.

PFERDVALUE:

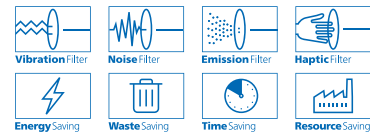

D [mm]	EAN 4007220	Opt. RPM	Max. RPM		Description
100	948224	1,900	12,000	5	CC-FR 100
115	936061	1,650	10,500	5	CC-FR 115
125	936078	1,500	9,650	5	CC-FR 125



CC-GT type

With this backing pad, COMBICLICK tools can be used on commercially available angle grinders. The different hardnesses are colour-coded:

- CC-GT (medium) = black
- CC-H-GT (hard) = blue

Advantages:

- The geometry of the cooling slots significantly reduces the thermal load.
- High economic efficiency due to minimized tool change times.

Recommendations for use:

- Type CC-H-GT is mainly used to work on stainless steel (INOX). It features very high edge strength, which enables a higher contact pressure.

Safety notes:

- The maximum peripheral speed is 80 m/s.
- For backing pads with a diameter of 180 mm, do not apply too high a contact pressure in order to prevent the backing pad from overstretching.

PFERDVALUE:

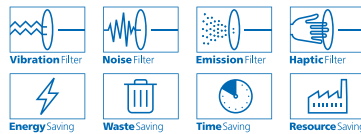

Suitable for CC diameter [mm]	Thread	Hardness	Suitable for machine types	EAN 4007220	Max. RPM		Description
100	M10	medium	Angle grinders 100, spindle M10	836200	15,300	1	CC-GT 100 M10
115, 125	M14	medium	Angle grinders 115 / 125, spindle M14	725764	13,300	1	CC-GT 115-125 M14
	5/8	medium	Angle grinders 115 / 125, spindle 5/8"	725771	13,300	1	CC-GT 115-125 5/8
	M14	hard	Angle grinders 115 / 125, spindle M14	835869	13,300	1	CC-H-GT 115-125 M14
	5/8	hard	Angle grinders 115 / 125, spindle 5/8"	841419	13,300	1	CC-H-GT 115-125 5/8
180	M14	medium	Angle grinders 180, spindle M14	725788	8,500	1	CC-GT 180 M14
	5/8	medium	Angle grinders 180, spindle 5/8"	725795	8,500	1	CC-GT 180 5/8



Set

CC-SET

Set for surface work, from coarse to mirror-polished. The sets with a diameter of 125 mm are especially flexible around the edge.

Contents:

- 3 pcs. each of COMBICLICK fibre discs:
 - CC-FS CO-COOL 36
 - CC-FS CO-COOL 120
 - CC-FS A-COOL 220
- 1 pc. each of COMBICLICK non-woven disc:
 - CC-VRH A 240 F
 - CC-VRH A 180 M
 - CC-VRH A 100 G
 - CC-VRW A 280
 - CC-VRW A 180
 - CC-VRW A 100
 - CC-PNER W SiC F
- 1 pc. each of:
 - Universal polishing paste
 - COMBICLICK felt disc CC-FR
 - COMBICLICK backing pad CC-GT M14 or 5/8-11

Advantages:

- Getting to know and testing the comprehensive system.
- Coordinated selection of the most common versions.

Abrasive:

Aluminium oxide A
Ceramic oxide grain CO-COOL
Silicon carbide SiC

PFERDVALUE:

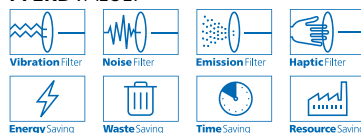

D [mm]	Thread	EAN 4007220		Description
115	M14	955345	1	CC-SET 115 M14
	5/8-11	955406	1	CC-SET 115 5/8-11
125	M14	955369	1	CC-SET 125 M14
	5/8-11	955413	1	CC-SET 125 5/8-11

Fibre discs

General information

The wide range of fibre discs offers the best tool for any grinding application, from coarse to fine. PFERD fibre discs are manufactured in compliance with ISO 16057 in shape A1, type F, under the designation "vulcanized fibre disc".

Advantages:

- High profitability thanks to long tool life and very high stock removal rate.
- Consistent surface finish thanks to high-quality abrasives.
- Optimum adaptation to contours thanks to high flexibility.

Applications:

- Levelling
- Deburring
- Surface work
- Work on edges
- Work on weld seams
- Step-by-step fine grinding

Recommendations for use:

- Use fibre discs conforming to ISO 15636 with backing pads on commercially available angle grinders.
- Use grinding oil which is suitable for the material in order to considerably increase the tool life and abrasive performance of the tools. More detailed information and ordering data for grinding oils can be found on page 155.

Matching tool drives:

- Angle grinders
- Cordless angle grinders

Ordering notes:

- Please order backing pads separately. More detailed information and ordering data for backing pads can be found on page 24.
- When ordering, please state the EAN or the full description.

Ordering example:

EAN 4007220**696354**

FS 115-22 A-COOL **60**

Ordering example explanation:

- FS = Fibre disc
- 115 = Outer diameter D [mm]
- 22 = Centre hole diameter H [mm]
- A = Abrasive
- COOL = Bond type
- 60** = Grit size

Safety notes:

- The maximum permitted peripheral speed is 80 m/s.
- For safety reasons, the specified maximum permitted rotational speed must never be exceeded.



Accessories:

- Backing pads

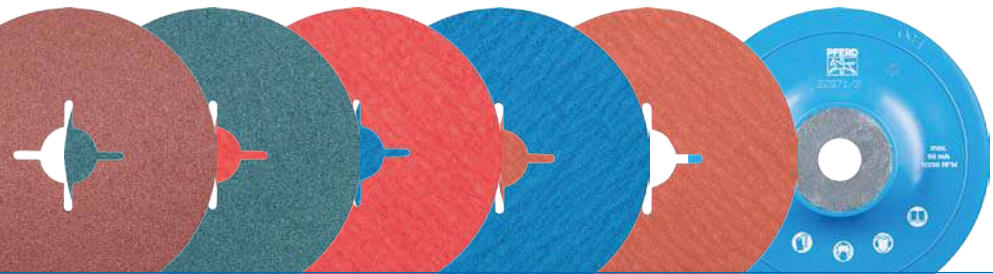

The fast way to the best tool

Material group ▼		Abrasive ►	Aluminium oxide A	Zirconia Alumina Z	Ceramic oxide grain CO	VICTO-GRAIN COOL	Aluminium oxide A-COOL	Zirconia Alumina Z-COOL	Ceramic oxide grain CO-COOL
Steel, cast steel	Non-hardened, non-heat-treated steels	Construction steels, carbon steels, tool steels, non-alloyed steels, cast steel	●	○	●	●			
	Hardened, heat-treated steels	Tool steels, tempering steels, alloyed steels, cast steel	○	●	●	●			
Stainless steel (INOX)	Rust- and acid-resistant steels	Austenitic and ferritic stainless steels		○		●	●	●	●
Non-ferrous metals	Soft non-ferrous metals, non-ferrous metals	Soft aluminium alloys	○				●	○	○
		Brass, copper, zinc	●	○	○				
	Hard non-ferrous metals	Hard aluminium alloys	●	○	○				
		Bronze, titanium		○	○	●		●	●
	High-temperature-resistant materials	Nickel-based and cobalt-based alloys		○	○	●		●	●
Cast iron	Grey cast iron, white cast iron	Cast iron with flake graphite EN-GJL (GG), with nodular graphite/nodular cast iron EN-GJS (GGG), white annealed cast iron EN-GJMW (GTW), black cast iron EN-GJMB (GTS)	●	○	●				
Plastics, other materials		Fibre-reinforced plastics, thermoplastics, wood, chipboard, paintwork	●						

● = Highly suitable

○ = Suitable

Aluminium oxide A type

For universal grinding work from coarse to fine grinding in industry and professional trades.

Abrasive:

Aluminium oxide A

Ordering notes:

■ Please complete the description with the desired grit size.

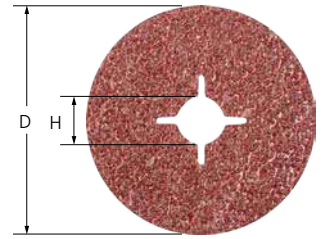

D [mm]	H [mm]	Grit size								Max. RPM		Description
		16	24	36	50	60	80	100	120			
EAN 4007220												
100	16	344477	228012	227442	301630	228319	228326	228043	306444	15,300	25	FS 100-16 A ...
115	22	164914	164952	165003	500910	165058	165102	165157	500934	13,300	25	FS 115-22 A ...
125	22	164921	164969	165010	696286	165065	165119	165164	500941	12,200	25	FS 125-22 A ...
150	22	-	-	165027	-	165072	165126	-	-	10,200	25	FS 150-22 A ...
180	22	164945	164983	165034	696323	165089	165133	165188	165201	8,500	25	FS 180-22 A ...

Zirconia alumina Z type

For coarse grinding work with a high stock removal rate and a long tool life.

Abrasive:

Zirconia alumina Z

Ordering notes:

■ Please complete the description with the desired grit size.

Recommendations for use:

■ Use powerful angle grinders in the case of a higher contact pressure.

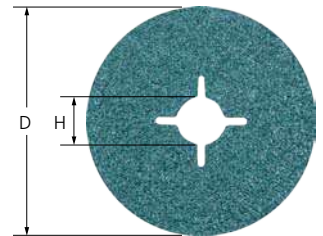

D [mm]	H [mm]	Grit size							Max. RPM		Description
		24	36	50	60	80	100	120			
EAN 4007220											
100	16	832943	832950	832967	750636	832974	750643	832981	15,300	25	FS 100-16 Z ...
115	22	216569	216576	216583	216590	216606	696606	696613	13,300	25	FS 115-22 Z ...
125	22	216613	216620	216637	216644	216651	696620	696637	12,200	25	FS 125-22 Z ...
180	22	216668	216675	216682	216699	216705	696644	696651	8,500	25	FS 180-22 Z ...

Ceramic oxide grain CO type

For aggressive grinding with a very high stock removal rate and very long tool life. Consistently high performance due to self-sharpening ceramic oxide grain.

The ceramic oxide grain is specifically designed for work on hard materials and layers.

Abrasive:

Ceramic oxide grain CO

Ordering notes:

■ Please complete the description with the desired grit size.

Recommendations for use:

■ Use powerful angle grinders.

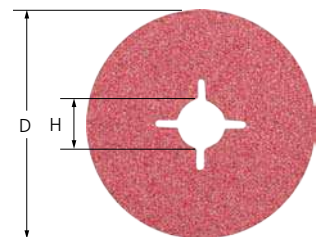

D [mm]	H [mm]	Grit size						Max. RPM		Description
		24	36	50	60	80	120			
EAN 4007220										
115	22	617434	617441	696781	617458	617465	696804	13,300	25	FS 115-22 CO ...
125	22	617472	617489	696811	617496	617502	696835	12,200	25	FS 125-22 CO ...
180	22	617519	617526	696842	617533	617540	696866	8,500	25	FS 180-22 CO ...



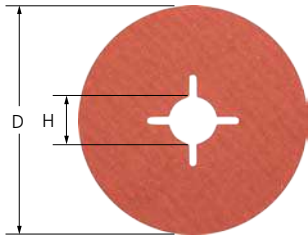

Aluminium oxide A-COOL type

For universal grinding work from fine to very fine grinding on materials which do not conduct heat well, e.g. stainless steel (INOX).

Active grinding additives in the coating substantially improve the stock removal rate, prevent clogging and result in cooler grinding.

Abrasive:
Aluminium oxide A-COOL

Ordering notes:
■ Please complete the description with the desired grit size.

D [mm]	H [mm]	Grit size					Max. RPM		Description			
		50	60	80	100	120				150	180	220
EAN 4007220												
115	22	696347	696354	696361	696378	696385	696392	696408	696415	13,300	25	FS 115-22 A-COOL ...
125	22	696422	696439	696446	696453	696460	696477	696484	696491	12,200	25	FS 125-22 A-COOL ...
180	22	696507	696514	696521	696538	696552	696583	696569	696590	8,500	25	FS 180-22 A-COOL ...

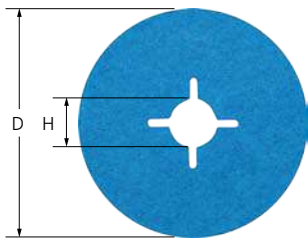

Zirconia alumina Z-COOL type

For coarse grinding work with a high stock removal rate and cool grinding.

Active grinding additives in the coating substantially improve the stock removal rate, prevent clogging and result in cooler grinding.

Abrasive:
Zirconia alumina Z-COOL

Ordering notes:
■ Please complete the description with the desired grit size.

Recommendations for use:
■ Use powerful angle grinders in the case of a higher contact pressure.

D [mm]	H [mm]	Grit size				Max. RPM		Description
		36	50	60	80			
EAN 4007220								
115	22	696668	696675	696682	696699	13,300	25	FS 115-22 Z-COOL ...
125	22	696705	696712	696729	696736	12,200	25	FS 125-22 Z-COOL ...

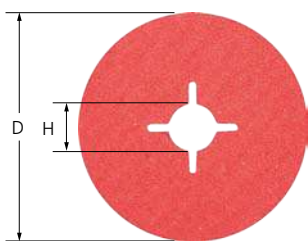

Ceramic oxide grain CO-COOL type

For aggressive grinding with maximum stock removal rate on hard materials which do not conduct heat well. Consistently high performance due to self-sharpening ceramic oxide grain.

Active grinding additives in the coating substantially improve the stock removal rate, prevent clogging and result in cooler grinding.

Abrasive:
Ceramic oxide grain CO-COOL

Ordering notes:
■ Please complete the description with the desired grit size.

D [mm]	H [mm]	Grit size					Max. RPM		Description		
		24	36	50	60	80				100	120
EAN 4007220											
100	16	899625	832998	833001	833018	833025	-	908129	15,300	25	FS 100-16 CO-COOL ...
115	22	696880	696897	696903	696910	696927	696934	696941	13,300	25	FS 115-22 CO-COOL ...
125	22	696958	696965	696972	696989	696996	697009	697016	12,200	25	FS 125-22 CO-COOL ...
180	22	697023	697030	697047	697054	697061	697078	697085	8,500	25	FS 180-22 CO-COOL ...

VICTOGRAIN-COOL type

For extremely aggressive grinding with an extremely long tool life and an outstanding stock removal rate on steels and materials which are hard or have poor heat-conducting properties.

Outstanding, constant high performance thanks to the **VICTOGRAIN** abrasive grain.

Active grinding additives in the coating substantially improve the stock removal rate, prevent clogging and result in cooler grinding.

Abrasive:
VICTOGRAIN-COOL

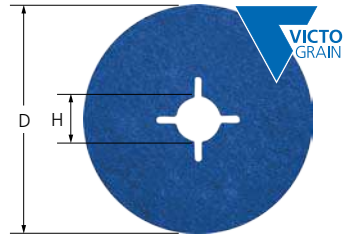

D [mm]	H [mm]	EAN 4007220	Max. RPM		Description
100	16	108796	15,300	25	FS 100-16 VICTOGRAIN-COOL 36
115	22	108789	13,300	25	FS 115-22 VICTOGRAIN-COOL 36
125	22	108802	12,200	25	FS 125-22 VICTOGRAIN-COOL 36
180	22	108819	8,500	25	FS 180-22 VICTOGRAIN-COOL 36

High-performance tools with VICTOGRAIN abrasive grain

VICTOGRAIN products are some of the most effective grinding tools in the world. PFERD's triangular, precision-formed abrasive grain achieves uniquely high abrasive performance.

The **VICTOGRAIN** abrasive grain triangles are identical in shape and size and their cutting edges are applied to the workpiece at the optimum angle, meaning the grain needs very little energy to penetrate the workpiece. As such, the user benefits from an efficient machining process with

- fast working,
- a long tool life,
- less heat build-up in the workpiece, and
- a lower power output required for the tool drive.

The **VICTOGRAIN** abrasive grain triangles are fixed to the substrate on one of their sides. This means they are securely fixed in place and, together with their slim design, offer an extremely large chip space in order to further improve machining efficiency.

The structure of the triangular **VICTOGRAIN** has also been specially adapted to maximize results. The very small crystals inside the triangles ensure optimal wear characteristics as sharp cutting edges are always exposed, but only the minimum amount of abrasive grain/the triangle breaks off.

By combining all these properties together, users benefit from optimal, constant performance during cool grinding and an extremely long tool life together with consistent workpiece surface roughness.

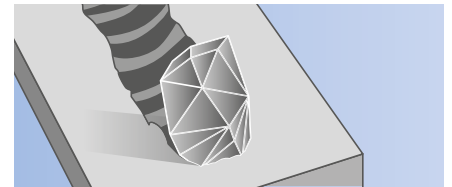

Conventional abrasive grain

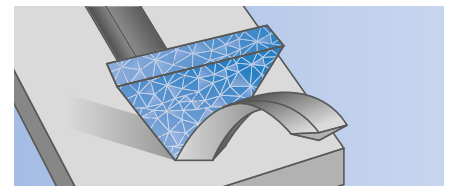

VICTOGRAIN abrasive grain



The **VICTOGRAIN** abrasive grain is optimally aligned





GT, H-GT and HT-GT types

Three different backing pad types are supplied for using fibre discs on commercially available angle grinders.

GT:

Backing pad for optimum adaptation to contours thanks to high flexibility. According to ISO 15636.

H-GT:

High-performance backing pad with a long tool life thanks to abrasion-resistant, glass-fibre-reinforced plastic. Impresses with particularly cool grinding due to radially arranged cooling fins, and high fibre disc stock removal rate due to sturdy, rigid design.

HT-GT:

Flexible and extremely temperature-resistant backing pad with a long tool life due to the highly temperature-resistant material. Enables high-precision work thanks to high flexibility. According to ISO 15636.

Ordering notes:

■ The matching clamping nut is included.

Accessories:

■ Clamping nuts for backing pads GT

Suitable for tool dia. [mm]	Thread	Suitable for machine types	EAN 4007220	Max. RPM		Description
GT						
100	M10	Angle grinders 100, spindle M10	100998	15,300	1	GT 100 MF M10
115	M10	Angle grinders 115, spindle M10	668047	13,300	1	GT 115 MF M10
	M14	Angle grinders 115, spindle M14	668054	13,300	1	GT 115 MF M14
125	M14	Angle grinders 125, spindle M14	668061	12,200	1	GT 125 MF M14
150	M14	Angle grinders 150, spindle M14	668078	10,200	1	GT 150 MF M14
180	M14	Angle grinders 180, spindle M14	668085	8,500	1	GT 180 MF M14
H-GT, high-performance backing pad						
115	M14	Angle grinders 115, spindle M14	668115	13,300	1	H-GT 115 MF M14
125	M14	Angle grinders 125, spindle M14	668122	12,200	1	H-GT 125 MF M14
180	M14	Angle grinders 180, spindle M14	668139	8,500	1	H-GT 180 MF M14
HT-GT, temperature-resistant backing pad						
115	M14	Angle grinders 115, spindle M14	032398	13,300	1	HT-GT 115 MF M14
125	M14	Angle grinders 125, spindle M14	032404	12,200	1	HT-GT 125 MF M14
180	M14	Angle grinders 180, spindle M14	032381	8,500	1	HT-GT 180 MF M14



FL-GT, clamping nuts for backing pads GT

Accessories for GT-type backing pads.

Advantages:

■ Matching centre hole distances for standard commercial face pin spanners.

Thread	Suitable for machine types	EAN 4007220		Description
M10	Angle grinders 100–115, spindle M10	668146	1	FL-GT 100-115 M10
M14	Angle grinders 80–115, spindle M14	668153	1	FL-GT 80-115 M14
	Angle grinders 125, spindle M14	668160	1	FL-GT 125 M14
	Angle grinders 150–230, spindle M14	668177	1	FL-GT 150-230 M14



Self-adhesive discs are suited to grinding larger surfaces.

The flexible system comprising a self-adhesive disc and the associated holder enables use on contours.

With the self-adhesive disc holder, self-adhesive discs can be used on commercially available, speed-adjustable or slow-running angle grinders with an M14 spindle.

Advantages:

- Quick tool changes thanks to self-adhesive system.
- Optimum adaptation to contours thanks to high flexibility.

Materials that can be worked:

- Can be used on nearly all materials.

Applications:

- Levelling
- Deburring
- Surface work
- Work on edges
- Work on weld seams
- Step-by-step fine grinding

Recommendations for use:

- The best grinding results are achieved with speed-adjustable angle grinders.
- Use grinding oil which is suitable for the material in order to considerably increase the tool life and abrasive performance of the tools. More detailed information and ordering data for grinding oils can be found on page 155.

Matching tool drives:

- Angle grinders
- Cordless angle grinders

Ordering notes:

- Please order self-adhesive disc holders separately. More detailed information and ordering data for self-adhesive disc holders can be found on page 26.

Safety notes:

- The maximum permitted peripheral speed is 32 m/s.
- For safety reasons, the specified maximum permitted rotational speed must never be exceeded.
- Position the self-adhesive discs centrally on the holder.



Accessories:

- Self-adhesive disc holders

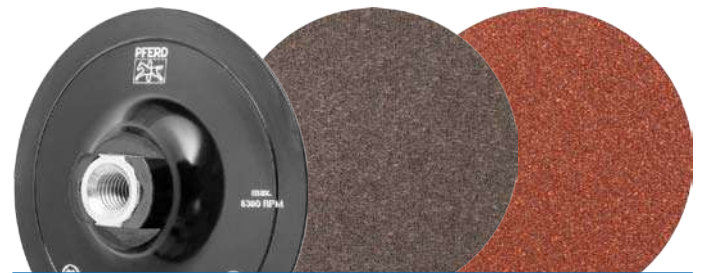

Self-adhesive discs KR

Aluminium oxide A type

For universal grinding work from coarse to fine grinding in industry and professional trades.

Advantages:

- Suitable for universal use on virtually all materials.

Ordering notes:

- Please complete the description with the desired grit size.

Abrasive:

Aluminium oxide A



D ₁ [mm]	Grit size						Opt. RPM	Max. RPM		Description
	40	60	80	120	150	180				
	EAN 4007220									
115	294291	294307	294314	294321	294338	294345	5,000	5,300	50	KR 115 A ...
125	294352	294369	294376	294383	294390	294406	4,600	4,850	50	KR 125 A ...



Self-adhesive discs

Self-adhesive discs KR



Aluminium oxide A compact grain type

The wide range of different grains makes this range outstandingly suited to fine and very fine grinding, and for step-by-step preparations for polishing.

Advantages:

- Very long tool life and consistent surface roughness over the entire lifespan thanks to self-sharpening compact grain.

Abrasive:

Aluminium oxide A compact grain

Ordering notes:

- Please complete the description with the desired grit size.

D ₁ [mm]	Grit size									Opt. RPM	Max. RPM		Description
	120	180	240	320	400	600	800	1000	1200				
EAN 4007220													
115	026113	026168	026175	026199	026205	026212	026229	026236	026243	5,000	5,300	50	KR 115 A ... CK
125	026250	026267	026274	026281	026298	026304	026311	026328	026335	4,600	4,850	50	KR 125 A ... CK

Self-adhesive disc holders KRH



KRH type

Flexible arbor for using self-adhesive discs on commercially available angle grinders.

D [mm]	Thread	EAN 4007220	Max. RPM		Description
115	M14	294413	5,300	1	KRH 115 M14
125	M14	294420	4,850	1	KRH 125 M14



The comprehensive range of self-adhesive abrasive discs and abrasive disc holders is specifically intended for tool- and mould-making.

Advantages:

- Optimum adaptation to contours thanks to high flexibility.
- Quick and easy tool changes.
- Secure hold of the disc on the holder thanks to high-quality adhesive connections.

Materials that can be worked:

- Can be used on nearly all materials.

Applications:

- Levelling
- Surface work
- Finishing
- Step-by-step fine grinding

Recommendations for use:

- Use abrasive discs with abrasive disc holders.
- Use grinding oil which is suitable for the material in order to considerably increase the tool life and abrasive performance of the tools. More detailed information and ordering data for grinding oils can be found on page 155.

Matching tool drives:

- Flexible shaft drives
- Straight grinders

Safety notes:

- The maximum permitted peripheral speed is 20 m/s.
- For safety reasons, the specified maximum permitted rotational speed must never be exceeded.



Accessories:

- Abrasive disc holder



Self-adhesive abrasive discs PSA and abrasive disc holders PSA-H

PSA type

For heavily contoured, delicate components. Different surface quality levels from coarse to very fine can be successively achieved.

Abrasive:

Aluminium oxide A

Ordering notes:

- Please order abrasive disc holders separately.
- Please complete the description with the desired grit size.



D ₁ [mm]	Grit size								Opt. RPM	Max. RPM		Description
	60	80	120	180	240	320	400	600				
EAN 4007220												
12	026182	026731	026991	027004	027011	027028	027035	027042	16,000	31,800	100	PSA 12 A ...
20	027059	027066	027080	027097	027103	027110	027127	027134	10,000	19,100	100	PSA 20 A ...
30	027141	027158	027165	027172	027189	027196	027202	027219	6,500	12,700	100	PSA 30 A ...
50	027226	027233	027240	027257	027264	027271	027288	027295	4,000	7,650	100	PSA 50 A ...

PSA-H type

Flexible abrasive disc holder for using self-adhesive abrasive discs.

Recommendations for use:

- When working on narrow radii, choose the abrasive disc holder to be one size smaller than the abrasive disc so that the outer

edges of the abrasive disc can adapt to the contour of the radius.



D [mm]	S [mm]	L [mm]	Suitable for	EAN 4007220	Max. RPM		Description
Shank dia. 2.35 mm							
10	2.35	35	PSA 12	026885	31,800	5	PSA-H 12-2,35
18	2.35	35	PSA 20	026939	19,100	5	PSA-H 20-2,35
25	2.35	35	PSA 30	026953	12,700	5	PSA-H 30-2,35
Shank dia. 3 mm							
10	3	35	PSA 12	026922	31,800	5	PSA-H 12-3
18	3	35	PSA 20	026946	19,100	5	PSA-H 20-3
25	3	35	PSA 30	026960	12,700	5	PSA-H 30-3
45	3	35	PSA 50	026984	7,650	5	PSA-H 50-3
Shank dia. 6 mm							
45	6	35	PSA 50	026977	7,650	5	PSA-H 50-6

The COMBIDISC product range contains a wide selection of grinding tools for surface finishing. From coarse machining and surface texturing to face-down mirror polishing – the range provides the best tool, even for complicated applications.

Advantages:

- High profitability thanks to quick tool changes.
- Great convenience thanks to simple handling and low-vibration working.
- No operational disruptions caused by sticking, slipping or disengaging.

Applications:

- Roughening
- Levelling
- Deburring
- Surface work
- Work on edges
- Polishing
- Cleaning
- Sharpening
- Work on weld seams
- Structuring surfaces
- Step-by-step fine grinding

Recommendations for use:

- Use COMBIDISC grinding tools with arbors or abrasive disc holders on flexible shaft drives with angle handpieces, compressed-air or electric angle grinders.
- Use grinding oil which is suitable for the material in order to considerably increase the tool life and abrasive performance of the tools. More detailed information and ordering data for grinding oils can be found on page 155.

Matching tool drives:

- Flexible shaft drives
- Straight grinders
- Angle grinders
- Cordless angle grinders

Ordering notes:

- Please order arbors or COMBIDISC abrasive disc holders separately. More detailed information and ordering data can be found on page 43.
- When ordering, please state the EAN or the full description.
- **Ordering example:**
EAN 4007220**266175**
CD 38 A **180**
- **Ordering example explanation:**
CD = COMBIDISC abrasive discs
38 = Outer diameter D₁ [mm]
A = Abrasive
180 = Grit size

Safety notes:

- The maximum permitted peripheral speed is 50 m/s.
- For safety reasons, the specified maximum permitted rotational speed must never be exceeded.



Accessories:

- Arbors for COMBIDISC Mini-POLIFAN
- COMBIDISC abrasive disc holders

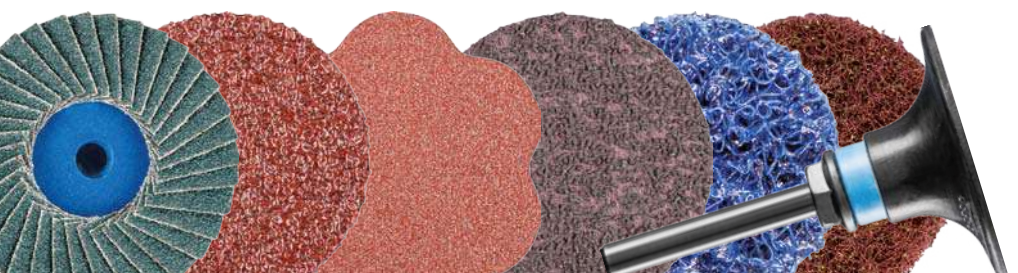

The fast way to the best tool

Material group ▼		Abrasive ►	Aluminium oxide A, A-PLUS, A-FLEX, A-CONTOUR, A-FORTE	Aluminium oxide A Compact grain	Zirconia alumina Z
Steel, cast steel	Non-hardened, non-heat-treated steels	Construction steels, carbon steels, tool steels, non-alloyed steels, cast steel	●		○
	Hardened, heat-treated steels	Tool steels, tempering steels, alloyed steels, cast steel	○	●	●
Stainless steel (INOX)	Rust- and acid-resistant steels	Austenitic and ferritic stainless steels		●	○
Non-ferrous metals	Soft non-ferrous metals, non-ferrous metals	Soft aluminium alloys	○		
		Brass, copper, zinc	●		○
	Hard non-ferrous metals	Hard aluminium alloys Bronze, titanium	●		○
	High-temperature-resistant materials	Nickel-based and cobalt-based alloys			○
Cast iron	Grey cast iron, white cast iron	Cast iron with flake graphite EN-GJL (GG), with nodular graphite/nodular cast iron EN-GJS (GGG), white annealed cast iron EN-GJMW (GTW), black cast iron EN-GJMB (GTS)	●		○
Plastics, other materials		Fibre-reinforced plastics, thermoplastics, wood, chipboard, paintwork	●		

● = Highly suitable ○ = Suitable

PFERD offers two alternative clamping systems:

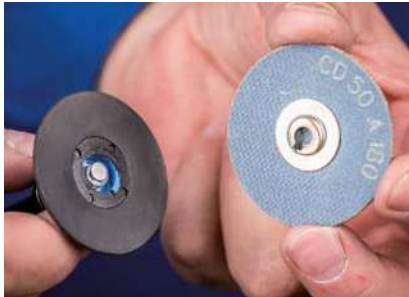

Tool side: Threaded connection with female thread (metal/plastic)
 Also suitable for the following systems used on the market: PSG, Power Lock Type II "turn on", SocAtt, Turn-On



Tool side: Threaded connection with male thread (plastic)
 Also suitable for the following systems used on the market: Roloc™, Lockit, Speed Lok TR, Power Lock Type III, Fastlock-System B, Roll-On

PFERDVALUE:

PFERDERGONOMICS recommends COMBIDISC tools as a solution to sustainably reduce vibration, noise and dust levels produced by tools and to improve working comfort.

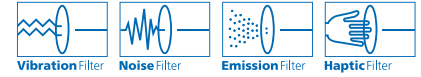

PFERDEFFICIENCY recommends COMBIDISC tools to reduce tool change and setup times.



Recommended rotational speed range

Example:
 CD 50 A-COOL 60
 Application:
 Grinding stainless steel (INOX)
 Cutting speed: 20–25 m/s
Rotational speed: 7,600–9,500 RPM

D ₁ [mm]	Cutting speed [m/s]								
	5	10	15	20	25	30	35	40	50
	Rotational speeds [RPM]								
20	4,700	9,500	14,300	19,000	23,800	28,600	33,400	38,100	47,700
25	3,800	7,600	11,400	15,200	19,000	22,900	26,700	30,500	38,100
38	2,500	5,000	7,500	10,000	12,500	15,000	17,500	20,100	25,100
50	1,900	3,800	5,700	7,600	9,500	11,400	13,300	15,200	19,000
75	1,200	2,500	3,800	5,000	6,300	7,600	8,900	10,100	12,700

Silicon carbide SiC	Aluminium oxide A-COOL	Ceramic oxide grain CO-COOL	VICTOGRAIN-COOL 	Diamond abrasive discs	POLICLEAN discs	Non-woven discs PNER, VRH, VRW
		●	●		●	●
		●	●		○	○
	●	●	●		●	●
	●	○			●	●
○					●	●
●		●	●	●	○	●
		●	●	●	○	●
					●	●
●				●	●	●

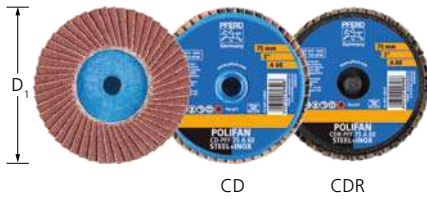

Aluminium oxide A type

For universal coarse grinding work with high stock removal rates.

Ideal for dressing weld seams in hard-to-reach places.

Longer tool life and higher stock removal rate when compared to abrasive discs.

Abrasive:
Aluminium oxide A

Ordering notes:

■ Please complete the description with the desired grit size.

PFERDVALUE:

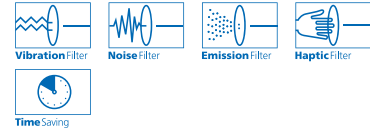

D ₁ [mm]	Grit size				Opt. RPM	Suitable arbors		Description
	40	60	80	120				
EAN 4007220								

CD system



50	617359	617366	617373	617380	12,000–14,000	BO PFF 50, SBH 20–50	10	CD PFF 50 A ...
75	617397	617403	617410	617625	8,000–10,000	BO PFF 75, SBH 75	10	CD PFF 75 A ...

CDR system



50	016121	016145	821633	016152	12,000–14,000	SBHR 20–75	10	CDR PFF 50 A ...
75	016169	016176	821640	016336	8,000–10,000	SBHR 20–75	10	CDR PFF 75 A ...

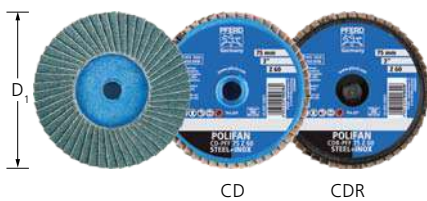

Zirconia alumina Z type

For coarse grinding work with a high stock removal rate and a long tool life.

Abrasive:
Zirconia alumina Z

Recommendations for use:

■ Use in the case of a higher contact pressure.

Ordering notes:

■ Please complete the description with the desired grit size.

PFERDVALUE:

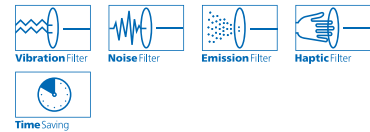

D ₁ [mm]	Grit size				Opt. RPM	Suitable arbors		Description
	40	60	80	120				
EAN 4007220								

CD system



50	592717	592724	592731	592748	12,000–14,000	BO PFF 50, SBH 20–50	10	CD PFF 50 Z ...
75	592755	592762	592779	592786	8,000–10,000	BO PFF 75, SBH 75	10	CD PFF 75 Z ...

CDR system



50	902707	902714	016534	016541	12,000–14,000	SBHR 20–75	10	CDR PFF 50 Z ...
75	835111	016558	016565	821688	8,000–10,000	SBHR 20–75	10	CDR PFF 75 Z ...

Mini-POLIFAN arbors

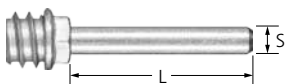

BO PFF

Matching arbors for COMBIDISC Mini-POLIFAN.

S [mm]	L [mm]	Suitable tool	EAN 4007220		Description
6	40	CD PFF 50	593196	1	BO PFF 50
		CD PFF 75	593202	1	BO PFF 75

Aluminium oxide A type

For universal coarse to fine grinding applications in industry and professional trades.

Abrasive:
Aluminium oxide A

Ordering notes:

- Please complete the description with the desired grit size.

PFERDVALUE:

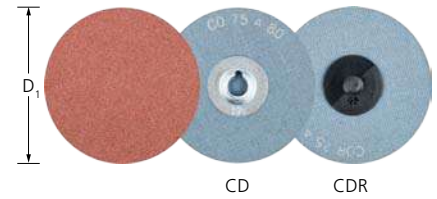
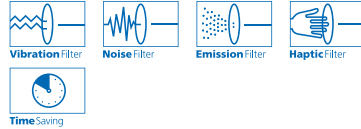

D ₁ [mm]	Grit size						Opt. RPM		Description
	36	60	80	120	180	320			
EAN 4007220									

CD system



20	-	265864	266007	266038	266052	266069	20,000–35,000	100	CD 20 A ...
25	-	355718	355725	355732	266083	266151	15,000–26,000	100	CD 25 A ...
38	355749	355756	355763	355770	266175	266199	10,000–16,000	100	CD 38 A ...
50	355787	355794	355800	355817	266212	266281	8,000–13,000	100	CD 50 A ...
75	355824	355831	355848	355855	266328	266359	5,000–9,000	50	CD 75 A ...

CDR system



20	-	778036	778043	778050	778074	778081	20,000–35,000	100	CDR 20 A ...
25	-	778098	778104	778111	778128	778135	15,000–26,000	100	CDR 25 A ...
38	596456	596463	596470	597255	597262	596500	10,000–16,000	100	CDR 38 A ...
50	596517	596524	596531	596548	596555	596562	8,000–13,000	100	CDR 50 A ...
75	596586	596593	596609	596616	596623	596630	5,000–9,000	50	CDR 75 A ...

Aluminium oxide A-PLUS type

For universal applications from coarse to fine grinding.

Higher stock removal rate due to sturdy backing material.
Particularly for use in edge grinding due to high tear strength.

Abrasive:
Aluminium oxide A-PLUS

Ordering notes:

- Please complete the description with the desired grit size.

PFERDVALUE:

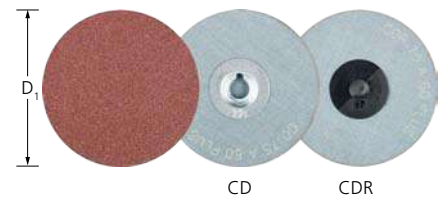
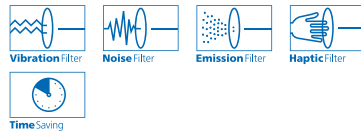

D ₁ [mm]	Grit size				Opt. RPM		Description
	36 PLUS	60 PLUS	80 PLUS	120 PLUS			
EAN 4007220							

CD system



50	593608	593615	593622	593653	8,000–13,000	100	CD 50 A ...
75	593660	593677	593684	593691	5,000–9,000	50	CD 75 A ...

CDR system



50	778302	778319	778326	778333	8,000–13,000	100	CDR 50 A ...
75	778340	778357	778364	778371	5,000–9,000	50	CDR 75 A ...



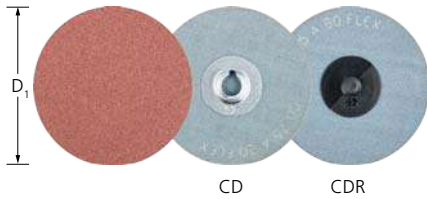

Aluminium oxide A-FLEX type

Particularly flexible abrasive discs, which are especially suitable for work on contours and concave surfaces, e.g. in tool- and mould-making. For achieving seamless transitions in the surface finish.

Abrasive:
Aluminium oxide A-FLEX

Recommendations for use:
■ These discs should be used with a soft holder to support their flexibility.

Ordering notes:
■ Please complete the description with the desired grit size.

PFERDVALUE:

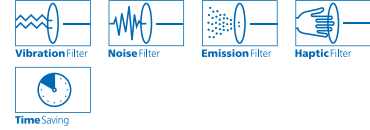

D ₁ [mm]	Grit size			Opt. RPM		Description
	60 FLEX	80 FLEX	120 FLEX			
EAN 4007220						
CD system						
38	638842	638859	638866	10,000–16,000	100	CD 38 A ...
50	638873	638880	638897	8,000–13,000	100	CD 50 A ...
75	638903	638910	638927	5,000–9,000	50	CD 75 A ...
CDR system						
38	778166	778159	778173	10,000–16,000	100	CDR 38 A ...
50	778180	778210	778227	8,000–13,000	100	CDR 50 A ...
75	778241	778272	778296	5,000–9,000	50	CDR 75 A ...

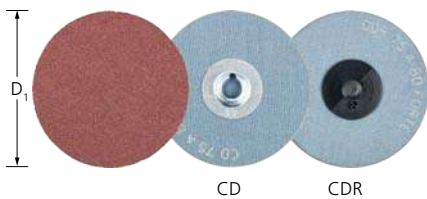

Aluminium oxide A-FORTE type

For universal applications from coarse to fine grinding, with a high stock removal rate and long tool life.

Abrasive:
Aluminium oxide A-FORTE

Ordering notes:
■ Please complete the description with the desired grit size.

PFERDVALUE:

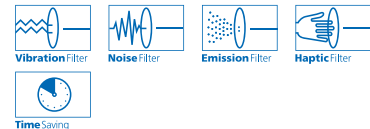

D ₁ [mm]	Grit size				Opt. RPM		Description
	36 FORTE	60 FORTE	80 FORTE	120 FORTE			
EAN 4007220							
CD system							
25	-	265833	266021	266045	15,000–26,000	100	CD 25 A ...
38	266076	266090	266106	266113	10,000–16,000	100	CD 38 A ...
50	266120	266137	266144	266168	8,000–13,000	100	CD 50 A ...
75	266182	266205	266229	266250	5,000–9,000	50	CD 75 A ...
CDR system							
25	-	778388	778395	778401	15,000–26,000	100	CDR 25 A ...
38	596647	596661	596678	596685	10,000–16,000	100	CDR 38 A ...
50	596692	596708	596715	596722	8,000–13,000	100	CDR 50 A ...
75	596739	596746	596753	596760	5,000–9,000	50	CDR 75 A ...



Aluminium oxide A-COOL type

For universal applications from coarse to fine grinding on materials with challenging stock removal properties, e.g. stainless steel (INOX).

Active grinding additives in the coating substantially improve the stock removal rate, prevent clogging and result in cooler grinding.

Abrasive:

Aluminium oxide A-COOL

Ordering notes:

- Please complete the description with the desired grit size.

PFERDVALUE:

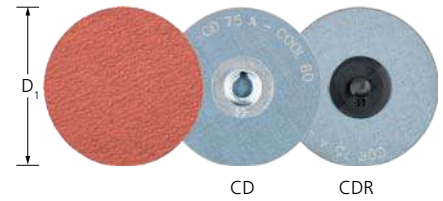
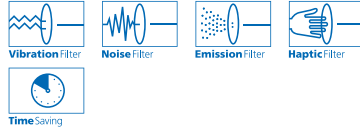

D ₁ [mm]	Grit size			Opt. RPM		Description
	36	60	80			
EAN 4007220						
CD system						
50	265840	266427	266434	8,000–13,000	100	CD 50 A-COOL ...
75	266441	266458	266465	5,000–9,000	50	CD 75 A-COOL ...
CDR system						
50	596777	596784	596791	8,000–13,000	100	CDR 50 A-COOL ...
75	596807	596814	596821	5,000–9,000	50	CDR 75 A-COOL ...

Aluminium oxide A compact grain type

Outstandingly suited to fine and very fine grinding, and for step-by-step preparations for polishing.

The self-sharpening compact grain facilitates a very long tool life and achieves consistent surface quality levels throughout the entire tool life.

Abrasive:

Aluminium oxide A compact grain

Ordering notes:

- Please complete the description with the desired grit size.

PFERDVALUE:

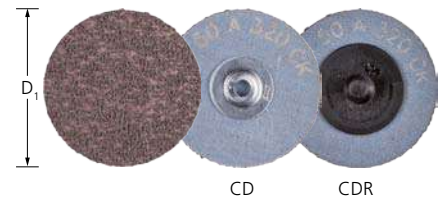
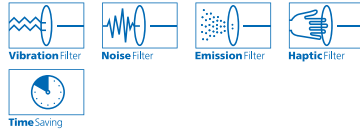

D ₁ [mm]	Grit size									Opt. RPM		Description
	120	180	240	320	400	600	800	1000	1200			
EAN 4007220												
CD system												
50	003169	065594	065600	065860	065921	065976	066539	066546	066553	3,800–13,000	100	CD 50 A ... CK
75	066775	066782	066799	066805	066812	066836	066843	066850	066867	2,500–9,000	50	CD 75 A ... CK
CDR system												
50	066577	066591	066607	066621	066638	066645	066652	066669	066737	3,800–13,000	100	CDR 50 A ... CK
75	066874	066881	066904	067123	067130	067161	067185	067192	067208	2,500–9,000	50	CDR 75 A ... CK



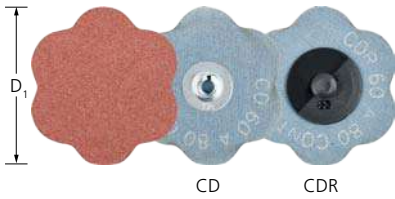

Aluminium oxide A-CONTOUR type

Very flexible and adaptable on account of the outer contour. Cutting into the workpiece is avoided.

Abrasive:
Aluminium oxide A-CONTOUR

Recommendations for use:
■ Use an abrasive disc holder with a diameter of 20–50 mm.

Ordering notes:
■ Please complete the description with the desired grit size.

PFERDVALUE:

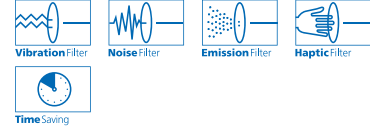

D ₁ [mm]	Grit size				Opt. RPM		Description
	60 CONTOUR	80 CONTOUR	120 CONTOUR	180 CONTOUR			
EAN 4007220							
CD system							
60	898802	898819	898826	898833	7,500–11,000	50	CD 60 A ...
CDR system							
60	898840	898857	898864	898871	7,500–11,000	50	CDR 60 A ...

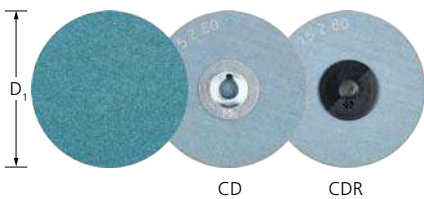

Zirconia alumina Z type

For coarse grinding work with a high stock removal rate and a long tool life.

Particularly high stock removal rate in coarse grinding applications using grit sizes 36 and 60.

Abrasive:
Zirconia alumina Z

Recommendations for use:
■ Use with hard or medium-hard COMBIDISC abrasive disc holders.

Ordering notes:
■ Please complete the description with the desired grit size.

PFERDVALUE:

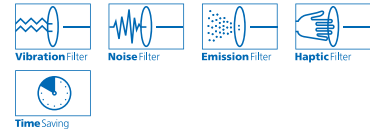

D ₁ [mm]	Grit size			Opt. RPM		Description
	36	60	80			
EAN 4007220						
CD system						
38	778418	778425	778432	5,000–16,000	100	CD 38 Z ...
50	265857	266472	266519	3,800–13,000	100	CD 50 Z ...
75	266526	266533	266540	2,500–9,000	50	CD 75 Z ...
CDR system						
38	778449	778456	778463	5,000–16,000	100	CDR 38 Z ...
50	596838	596845	596852	3,800–13,000	100	CDR 50 Z ...
75	596869	596876	596883	2,500–9,000	50	CDR 75 Z ...



Ceramic oxide grain CO-COOL type

For aggressive grinding with maximum stock removal rate on hard materials which do not conduct heat well. Consistently high performance due to self-sharpening ceramic oxide grain.

Active grinding additives in the coating substantially improve the stock removal rate, prevent clogging and result in cooler grinding.

Abrasive:

Ceramic oxide grain CO-COOL

Ordering notes:

- Please complete the description with the desired grit size.

PFERDVALUE:

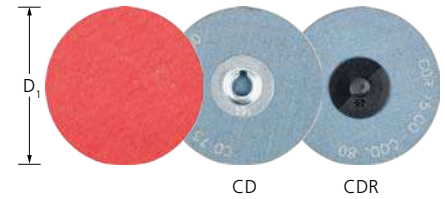
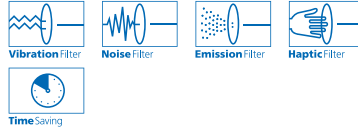

D ₁ [mm]	Grit size					Opt. RPM		Description
	24	36	60	80	120			
EAN 4007220								

CD system



38	770672	770689	770696	770702	770719	5,000–16,000	100	CD 38 CO-COOL ...
50	617922	617298	617304	617311	771365	3,800–13,000	100	CD 50 CO-COOL ...
75	617939	617328	617335	617342	771372	2,500–9,000	50	CD 75 CO-COOL ...

CDR system



38	778593	778609	778616	778623	778630	5,000–16,000	100	CDR 38 CO-COOL ...
50	778661	778678	778685	778692	778708	3,800–13,000	100	CDR 50 CO-COOL ...
75	778715	778722	778739	778746	778753	2,500–9,000	50	CDR 75 CO-COOL ...

Ceramic oxide grain CO-COOL midget fibre discs type

Exceptionally well-suited to surface and edge grinding. The fibre backing strengthens the abrasive disc and improves stock removal.

For aggressive grinding with maximum stock removal rate on hard materials which do not conduct heat well. Consistently high performance due to self-sharpening ceramic oxide grain.

Active grinding additives in the coating substantially improve the stock removal rate, prevent clogging and result in cooler grinding.

Abrasive:

Ceramic oxide grain CO-COOL

Ordering notes:

- Please complete the description with the desired grit size.

PFERDVALUE:

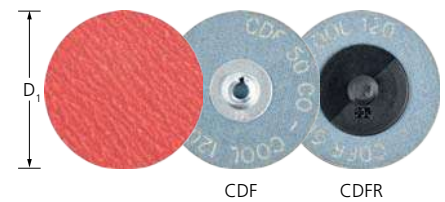
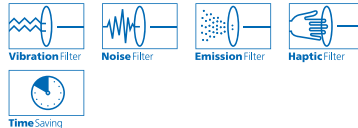

D ₁ [mm]	Grit size				Opt. RPM		Description
	36	50	80	120			
EAN 4007220							

CD system



50	778876	778883	778890	779156	3,800–13,000	100	CDF 50 CO-COOL ...
75	779163	779170	779187	779194	2,500–9,000	50	CDF 75 CO-COOL ...

CDR system



50	779200	779217	779224	779231	3,800–13,000	100	CDFR 50 CO-COOL ...
75	779255	779262	779279	779286	2,500–9,000	50	CDFR 75 CO-COOL ...

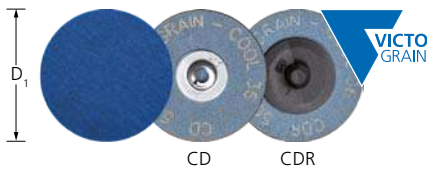

VICTOGRAIN-COOL type

For extremely aggressive grinding with an extremely long tool life and an outstanding stock removal rate on steels and materials which are hard or have poor heat-conducting properties.

Outstanding, constant high performance thanks to the **VICTOGRAIN-COOL** abrasive grain.

Active grinding additives in the coating substantially improve the stock removal rate, prevent clogging and result in cooler grinding.

Abrasive:
VICTOGRAIN-COOL

PFERDVALUE:

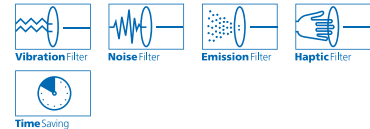

	D ₁ [mm]	EAN 4007220	Opt. RPM		Description
CD system					
	38	108857	5,000–16,000	100	CD 38 VICTOGRAIN-COOL
	50	109762	3,800–13,000	100	CD 50 VICTOGRAIN-COOL
	75	109779	2,500–9,000	50	CD 75 VICTOGRAIN-COOL
CDR system					
	38	109786	5,000–16,000	100	CDR 38 VICTOGRAIN-COOL
	50	109793	3,800–13,000	100	CDR 50 VICTOGRAIN-COOL
	75	109809	2,500–9,000	50	CDR 75 VICTOGRAIN-COOL

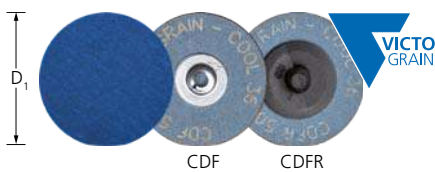

VICTOGRAIN-COOL midget fibre discs type

Exceptionally well-suited to surface and edge grinding. The fibre backing considerably strengthens the abrasive disc and improves stock removal.

For extremely aggressive grinding with an extremely long tool life and an outstanding stock removal rate on steels and materials which are hard or have poor heat-conducting properties.

Outstanding, constant high performance thanks to the **VICTOGRAIN-COOL** abrasive grain.

Active grinding additives in the coating substantially improve the stock removal rate, prevent clogging and result in cooler grinding.

Abrasive:
VICTOGRAIN-COOL

PFERDVALUE:

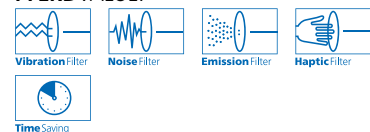

	D ₁ [mm]	EAN 4007220	Opt. RPM		Description
CD system					
	38	109298	5,000–16,000	100	CDF 38 VICTOGRAIN-COOL 36
	50	109304	3,800–13,000	100	CDF 50 VICTOGRAIN-COOL 36
	75	109311	2,500–9,000	50	CDF 75 VICTOGRAIN-COOL 36
CDR system					
	38	109328	5,000–16,000	100	CDFR 38 VICTOGRAIN-COOL 36
	50	109335	3,800–13,000	100	CDFR 50 VICTOGRAIN-COOL 36
	75	109342	2,500–9,000	50	CDFR 75 VICTOGRAIN-COOL 36

High-performance tools with VICTOGRAIN abrasive grain



VICTOGRAIN products are some of the most effective grinding tools in the world. PFERD's triangular, precision-formed abrasive grain achieves uniquely high abrasive performance.

The VICTOGRAIN abrasive grain triangles are identical in shape and size and their cutting edges are applied to the workpiece at the optimum angle, meaning the grain needs very little energy to penetrate the workpiece. As such, the user benefits from an efficient machining process with

- fast working,
- a long tool life,
- less heat build-up in the workpiece, and
- a lower power output required for the tool drive.

The VICTOGRAIN abrasive grain triangles are fixed to the substrate on one of their sides. This means they are securely fixed in place and, together with their slim design, offer an extremely large chip space in order to further improve machining efficiency.

The structure of the triangular VICTOGRAIN has also been specially adapted to maximize results. The very small crystals inside the triangles ensure optimal wear characteristics as sharp cutting edges are always exposed, but only the minimum amount of abrasive grain/the triangle breaks off.

By combining all these properties together, users benefit from optimal, constant performance during cool grinding and an extremely long tool life together with consistent workpiece surface roughness.

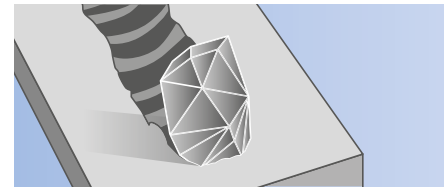

Conventional abrasive grain

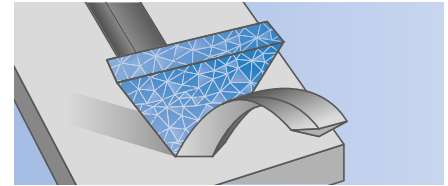

VICTOGRAIN abrasive grain



The VICTOGRAIN abrasive grain is optimally aligned



Diamond type

Exceptionally suitable for work on wear-resistant coatings and for hard facings made of tungsten carbide, chromium carbide, titanium carbide, etc. Particularly recommended for work on materials used for aircraft engine construction, e.g. Hastelloy, Inconel and titanium/titanium alloys. Also highly suitable for work on extremely hard materials such as tungsten carbide, glass, ceramics, enamel, stone and GRP/CRP.

Detailed information on diamond grinding tools can be found in catalogue section 5.

Abrasive:

Diamond

D 251 = P 60

D 126 = P 120

D 76 = P 220

(P = Grit size according to ISO 6344)

Recommendations for use:

- For the best results, use at a recommended cutting speed of 10–20 m/s.
- Use with hard or medium-hard COMBIDISC abrasive disc holders.

Ordering notes:

- Please complete the description with the desired grit size.
- Grit sizes are indicated in μm .

PFERDVALUE:

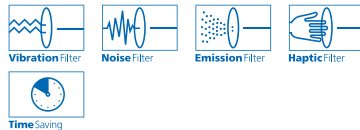

D ₁ [mm]	Grit size [μm]			Opt. RPM		Description
	251	126	76			
EAN 4007220						

CD system



25	750292	750315	750322	7,500–15,000	10	CD DIA 25 D ...
38	750339	750346	750353	5,000–10,000	10	CD DIA 38 D ...
50	750360	750377	750384	3,800–7,500	10	CD DIA 50 D ...
75	750391	750407	750414	2,500–5,000	10	CD DIA 75 D ...

CDR system



25	750421	750438	750445	7,500–15,000	10	CDR DIA 25 D ...
38	750452	750469	750476	5,000–10,000	10	CDR DIA 38 D ...
50	750483	750490	750506	3,800–7,500	10	CDR DIA 50 D ...
75	750513	750520	750537	2,500–5,000	10	CDR DIA 75 D ...

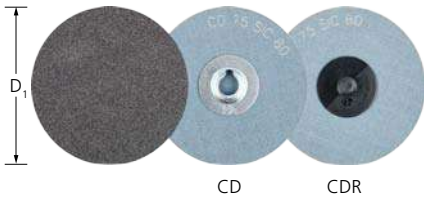

Silicon carbide SiC type

For universal grinding work on components made from aluminium, copper, bronze, titanium and fibre-reinforced plastics.

Particularly recommended for use on titanium alloys.

Ideally suited to use in the aeronautical industry, especially where SiC is the only approved abrasive, e.g. for use on engine components.

Abrasive:
Silicon carbide SiC

Ordering notes:
■ Please complete the description with the desired grit size.

PFERDVALUE:

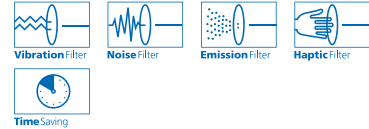

D ₁ [mm]	Grit size					Opt. RPM		Description
	36	60	80	120	240			
EAN 4007220								

CD system



50	441176	441183	441190	441206	441213	3,800–13,000	100	CD 50 SiC ...
75	441220	441237	441244	441251	441268	2,500–9,000	50	CD 75 SiC ...

CDR system



50	778470	778487	778494	778500	778517	3,800–13,000	100	CDR 50 SiC ...
75	778524	778548	778555	778562	778579	2,500–9,000	50	CDR 75 SiC ...

POLICLEAN discs CD, CDR



PCLR and PCLR PLUS types

For coarse cleaning work such as removing paint, scale, heat discoloration, rust and adhesive residues in face-down grinding.

POLICLEAN-PLUS discs (blue) exhibit a higher stock removal rate with a very long tool life.

Applications:
roughening, surface work, cleaning

Abrasive:
Aluminium oxide A
Silicon carbide SiC

Recommendations for use:
■ Use with hard or medium-hard COMBIDISC abrasive disc holders.

PFERDVALUE:

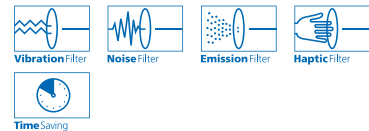

D ₁ [mm]	Type	Abrasives	EAN 4007220	Opt. RPM		Description
------------------------	------	-----------	----------------	-------------	--	-------------

CD system



50	PCLR	SiC	471500	5,500–8,000	10	CD 50 PCLR
75	PCLR	SiC	471517	3,800–5,000	10	CD 75 PCLR
50	PCLR PLUS	A	069288	5,500–8,000	10	CD 50 PCLR PLUS
75	PCLR PLUS	A	069295	3,800–5,000	10	CD 75 PCLR PLUS

CDR system



50	PCLR	SiC	677124	5,500–8,000	10	CDR 50 PCLR
75	PCLR	SiC	677131	3,800–5,000	10	CDR 75 PCLR
50	PCLR PLUS	A	069301	5,500–8,000	10	CDR 50 PCLR PLUS
75	PCLR PLUS	A	069318	3,800–5,000	10	CDR 75 PCLR PLUS

Hard type VRH

Suitable for universal work on small and medium-sized metal surfaces, e.g. removing rough grinding traces, removing oxidation and light deburring work. Achieve matt and satin-finished surfaces.

Applications:

roughening, deburring, surface work, cleaning, weld dressing, structuring, fine grinding in multiple steps

Abrasive:

Aluminium oxide A
Available POLIVLIES grit sizes:
100 G = coarse (yellow-brown)
180 M = medium (red-brown)
240 F = fine (blue)

Recommendations for use:



■ The addition of oil or water during grinding results in a finer finish, cooler grinding and longer tool life.

Ordering notes:

■ Please complete the description with the desired grit size.

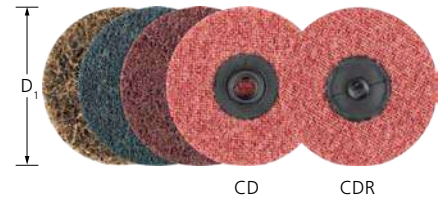
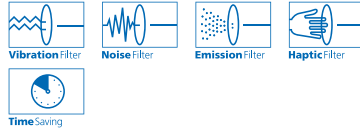
PFERDVALUE:



D ₁ [mm]	Grit size			Opt. RPM		Description
	100 G	180 M	240 F			
	EAN 4007220					
CD system 						
20	628218	584507	265871	14,000–19,000	50	CD VRH 20 A ...
25	268865	266564	266571	11,000–15,000	50	CD VRH 25 A ...
38	266588	266595	268872	7,000–10,000	50	CD VRH 38 A ...
50	266618	266625	266632	5,500–7,500	50	CD VRH 50 A ...
75	266649	266656	266663	3,800–5,000	25	CD VRH 75 A ...
CDR system 						
38	596906	596913	596920	7,000–10,000	50	CDR VRH 38 A ...
50	596937	596944	596951	5,500–7,500	50	CDR VRH 50 A ...
75	596968	596975	597354	3,800–5,000	25	CDR VRH 75 A ...



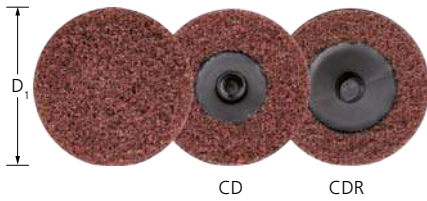

Soft type VRW

Suitable for very fine grinding on small and medium-sized surfaces and contours, and for cleaning metal and painted surfaces. Achieve matt and satin-finished surfaces. Highly open structure.

Applications:

roughening, deburring, surface work, cleaning, weld dressing, structuring, fine grinding in multiple steps

Abrasive:

Aluminium oxide A
Available POLINOX grit sizes:
100 = medium
180 = fine
280 = very fine

Recommendations for use:



■ The addition of oil or water during grinding results in a finer finish, cooler grinding and longer tool life.

Ordering notes:

■ Please complete the description with the desired grit size.

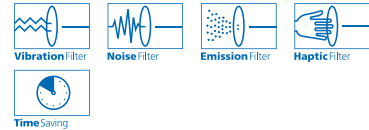
PFERDVALUE:



D ₁ [mm]	Grit size			Opt. RPM		Description
	100	180	280			
	EAN 4007220					
CD system 						
38	537039	450345	450352	7,000–10,000	50	CD VRW 38 A ...
50	266670	266687	266694	5,500–7,500	50	CD VRW 50 A ...
75	266717	266724	266731	3,800–5,000	25	CD VRW 75 A ...
CDR system 						
50	596999	597002	597019	5,500–7,500	50	CDR VRW 50 A ...
75	597026	597033	597040	3,800–5,000	25	CDR VRW 75 A ...



PNER type

For achieving a very fine, uniform surface finish which, depending on requirements, is a sufficient preparation for high-gloss polishing. Particularly suitable for work on small and medium-sized surfaces of stainless steel (INOX) components.

The different thicknesses/hardnesses of the non-woven material are colour-coded:

- W (soft) = grey
- MH (medium-hard) = dark blue
- H (hard) = red

Further information on non-woven products in the PNER type can be found on pages 99–100.

Applications:

roughening, deburring, surface work, cleaning, weld dressing, structuring, fine grinding in multiple steps

Abrasive:

Aluminium oxide A
Silicon carbide SiC

Ordering notes:

- Please complete the description with the desired grit size.

- The non-woven discs are supplied with a thickness of 6 mm.

PFERDVALUE:

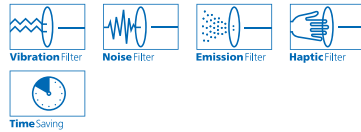

D ₁ [mm]	Type	Abrasives	Grit size		Opt. RPM	Max. RPM		Description
			G (coarse)	F (fine)				
			EAN 4007220					

CD system

50	soft	A	832783	-	9,500	19,100	25	CD PNER-W 5006 A ...
	soft	SiC	-	832776	9,500	19,100	25	CD PNER-W 5006 SiC ...
	medium-hard	A	-	832806	9,500	19,100	25	CD PNER-MH 5006 A ...
	medium-hard	SiC	-	832790	9,500	19,100	25	CD PNER-MH 5006 SiC ...
	hard	A	832851	832813	9,500	19,100	25	CD PNER-H 5006 A ...
75	soft	A	832868	-	6,400	12,500	25	CD PNER-W 7506 A ...
	soft	SiC	-	832837	6,400	12,500	25	CD PNER-W 7506 SiC ...
	medium-hard	A	-	832882	6,400	12,500	25	CD PNER-MH 7506 A ...
	medium-hard	SiC	-	832875	6,400	12,500	25	CD PNER-MH 7506 SiC ...
	hard	A	832905	832899	6,400	12,500	25	CD PNER-H 7506 A ...

CDR system

50	soft	A	832660	-	9,500	19,100	25	CDR PNER-W 5006 A ...
	soft	SiC	-	832653	9,500	19,100	25	CDR PNER-W 5006 SiC ...
	medium-hard	A	-	832684	9,500	19,100	25	CDR PNER-MH 5006 A ...
	medium-hard	SiC	-	832677	9,500	19,100	25	CDR PNER-MH 5006 SiC ...
	hard	A	832707	832691	9,500	19,100	25	CDR PNER-H 5006 A ...
75	soft	A	832721	-	6,400	12,500	25	CDR PNER-W 7506 A ...
	soft	SiC	-	832714	6,400	12,500	25	CDR PNER-W 7506 SiC ...
	medium-hard	A	-	832745	6,400	12,500	25	CDR PNER-MH 7506 A ...
	medium-hard	SiC	-	832738	6,400	12,500	25	CDR PNER-MH 7506 SiC ...
	hard	A	832769	832752	6,400	12,500	25	CDR PNER-H 7506 A ...



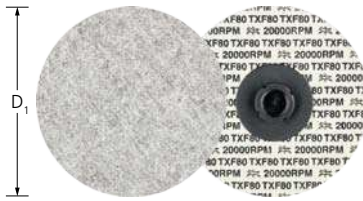

Aluminium oxide A type

For achieving fine, matt grinding finishes in one process. The very sturdy granular bond facilitates very aggressive abrasive performance. Particularly suitable for work on stainless steel (INOX) and aluminium.

Applications:
deburring, surface work, weld dressing, structuring, fine grinding in multiple steps

Abrasive:
Aluminium oxide A

Ordering notes:
■ Please complete the description with the desired grit size.

PFERDVALUE:

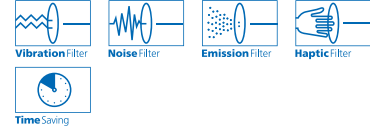

D ₁ [mm]	Grit size				Opt. RPM		Description
	36 TX	80 TX	120 TX	320 TX			
EAN 4007220							

CD system



50	505724	505731	505748	505755	7,500–9,500	25	CD 50 A ...
75	505786	505793	505809	505816	5,000–6,500	25	CD 75 A ...

Felt discs CD, CDR



FR type

Suitable for polishing with polishing paste bars, grinding pastes or diamond polishing pastes in face-down grinding on small and medium-sized surfaces.

Applications:
polishing

Recommendations for use:

- Use COMBIDISC felt discs with an abrasive disc holder on flexible shaft drives with an angle handpiece or small compressed-air or electric angle grinders.
- For the best results, use at a recommended cutting speed of 5–10 m/s. This provides an ideal compromise between polishing performance, thermal load on the workpiece and tool wear.
- When applying a different polishing paste, use a new unused felt disc.

Ordering notes:

- Further information on felt tools can be found on page 144.

Accessories:

- Grinding and polishing pastes

PFERDVALUE:

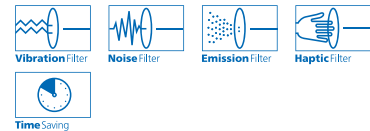

D ₁ [mm]	EAN 4007220	Opt. RPM		Description
------------------------	----------------	-------------	--	-------------

CD system



50	440490	2,000–4,000	10	CD FR 50
75	440506	1,200–2,500	10	CD FR 75

CDR system

50	004784	2,000–4,000	10	CDR FR 50
75	004791	1,200–2,500	10	CDR FR 75



SBH and SBHR types

Matching arbors for COMBIDISC grinding tools. Available in three different hardness grades.

Ordering notes:

- The different hardness grades are colour-coded: W (soft) – grey; M (medium) – blue; H (hard) – red
- Please complete the description with the desired hardness grade.

PFERDVALUE:

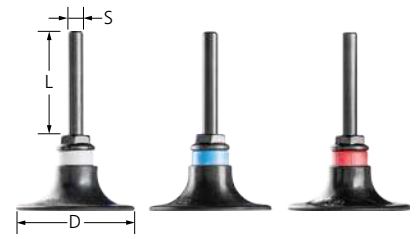
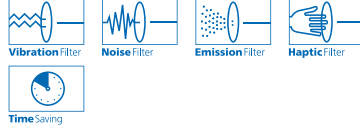

D [mm]	S [mm]	L [mm]	Hardness			Max. RPM		Description
			W (soft)	M (medium)	H (hard)			
EAN 4007220								

CD system

20	6	40	-	265901	-	47,500	1	SBH 20 ...
25	6	40	-	266755	-	38,000	1	SBH 25 ...
38	6	40	266762	266779	266786	25,000	1	SBH 38 ...
50	6	40	266793	266809	266816	19,000	1	SBH 50 ...
75	6	40	266823	266830	266847	12,500	1	SBH 75 ...

CDR system

20	6	40	-	776315	-	47,500	1	SBHR 20 ...
25	6	40	-	776322	-	38,000	1	SBHR 25 ...
38	6	40	776346	597057	776339	25,000	1	SBHR 38 ...
50	6	40	776360	597064	776353	19,000	1	SBHR 50 ...
75	6	40	776384	597071	776377	12,500	1	SBHR 75 ...

Adapters:

The shank of the abrasive disc holders can be replaced by suitable adapters. This enables the abrasive disc holder to be mounted directly to the drive spindle of the tool drive.

The following adapters are available:

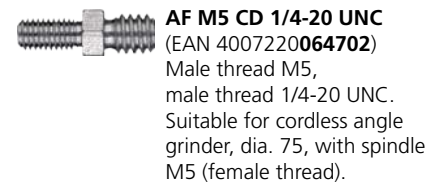
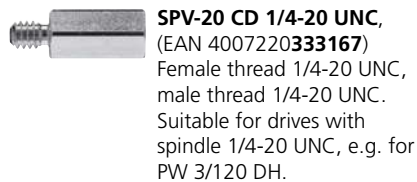
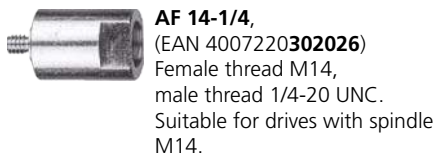

Ordering notes:

More detailed information and ordering data for adapters can be found in catalogue section 9.





COMBIDISC SET

Set of various COMBIDISC tools.

Contents:

- 3 pcs. each of COMBIDISC abrasive discs:
 - CD A 60 FORTE
 - CD A 120 FORTE
 - CD A-COOL 60
 - CD CO-COOL 36
 - CD Z 60
- 3 pcs. each of COMBIDISC non-woven discs:
 - CD VRH A 180 M
 - CD VRW A 100
- 1 pc. each of:
 - Abrasive disc holder SBH M

Advantages:

- Getting to know and testing the comprehensive system.
- Coordinated selection of the most common versions.

Abrasive:

Aluminium oxide A
Zirconia alumina Z
Aluminium oxide A-FORTE
Aluminium oxide A-COOL
Ceramic oxide grain CO-COOL

Recommendations for use:

- Use COMBIDISC grinding tools with an arbor or abrasive disc holder on flexible shaft drives with an angle handpiece or small compressed-air or electric angle grinders.

PFERDVALUE:

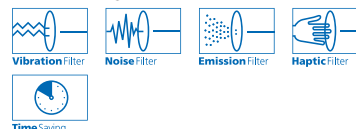

D ₁ [mm]	EAN 4007220		Description
50	265918	1	COMBIDISC-SET 50
75	265932	1	COMBIDISC-SET 75



SET CD UWER

Set of different COMBIDISC tools, including single-hand angle grinder, for all coarse and fine grinding, polishing and cleaning work, especially on assembly and construction sites.

Contents:

- Electric angle grinder UWER 5/200 SI with electronic rotational speed control (9,000–20,000 RPM), output 500 watts
- 4 abrasive disc holders and 2 adapters for alternative tool drives
- 135 different abrasive discs, TX discs, Mini-POLIFAN, non-woven and felt discs with a diameter of 50 mm
- Polishing paste bar for using felt discs

Advantages:

- Entire rotational speed range covered for COMBIDISC tools with a diameter of 50 mm.
- Easy and comfortable to use thanks to the handy angle grinder design.
- Coordinated selection of the most common versions.

Ordering notes:

- Detailed information and ordering data on tool drives can be found in catalogue section 9.

PFERDVALUE:

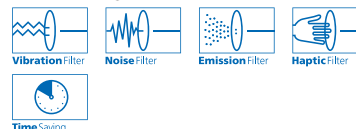

D ₁ [mm]	EAN 4007220		Description
50	607893	1	SET CD 50 UWER 5/200 230 V

PFERD supplies a comprehensive range of products which utilize flexible abrasives.

- Short and long belts
- Abrasive sheets, cloth and paper
- Hand pads, non-woven and diamond
- Shop rolls, non-woven, cloth and paper
- Velcro-backed abrasive discs

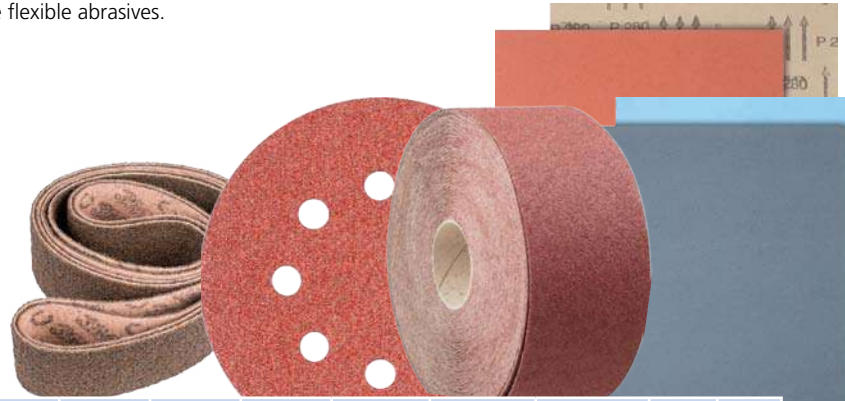

The fast way to the best tool

Material group ▼		Abrasive ▶	Recommended cutting speeds for short and long belts [m/s]	Aluminium oxide A	Zirconia alumina Z	Aluminium oxide A-COOL	Ceramic oxide grain CO	Ceramic oxide grain CO-COOL	Aluminium oxide A compact grain	Non-woven	Felt
Steel, cast steel	Non-hardened, non-heat-treated steels	Construction steels, carbon steels, tool steels, non-alloyed steels, cast steel	25–35	●	○		●			●	●
	Hardened, heat-treated steels	Tool steels, tempering steels, alloyed steels, cast steel	20–30	○	●		●		●	○	●
Stainless steel (INOX)	Rust- and acid-resistant steels	Austenitic and ferritic stainless steels	15–25		○	●		●	●	●	●
Non-ferrous metals	Soft non-ferrous metals, non-ferrous metals	Soft aluminium alloys	30–40	○		●		○		●	●
		Brass, copper, zinc		●	○		○		●	●	
	Hard non-ferrous metals	Hard aluminium alloys	20–30	●	○		○			●	●
		Bronze, titanium			○		○	●		●	●
	High-temperature-resistant materials	Nickel-based and cobalt-based alloys	5–15		○		○	●		●	●
Cast iron	Grey cast iron, white cast iron	Cast iron with flake graphite EN-GJL (GG), with nodular graphite/nodular cast iron EN-GJS (GGG), white annealed cast iron EN-GJMW (GTW), black cast iron EN-GJMB (GTS)	25–35	●	○		●			●	
Plastics, other materials		Fibre-reinforced plastics, thermoplastics, wood, chipboard, paintwork	10–25	●						●	●

● = Highly suitable ○ = Suitable

Coated abrasives

General information – Short and long belts

The comprehensive range of short and long belts is tailored to the belt grinders that are commonly found on the market.

Short and long belts from PFERD are designated as "abrasive belts" in ISO 2976.

Advantages:

- High profitability thanks to high abrasive performance and long tool life.
- High tear strength with optimum flexibility.
- Consistent work results thanks to very high grain adhesion.

Applications:

- Levelling
- Deburring
- Work on edges
- Sharpening
- Work on weld seams
- Step-by-step fine grinding

Recommendations for use:

- Use grinding oil which is suitable for the material in order to considerably increase the tool life and abrasive performance of the tools. More detailed information and ordering data for grinding oils can be found on page 155.

Matching tool drives:

- Belt grinders

Ordering notes:

- When ordering, please state the EAN or the full description. Please include the desired grit size with the description.

■ **Ordering example:**
EAN 4007220585269
BA 10/480 A 80

Ordering example explanation:

- BA = Abrasive belt
- 10 = Width T [mm]
- 480 = Length L [mm]
- A = Abrasive
- 80 = Grit size

Safety notes:

- Observe the safety notes "Safety notes for the correct use of abrasive belts" provided by the German Abrasives Association (VDS). You can find this information at www.pferd.com.



Recommended rotational speed range

Using the table opposite, you can determine the rotational speed in RPM based on the cutting speed. Please refer to page 45 for the recommended cutting speeds.

Example:

BA 16/480 A 60

Diameter of the drive roller: 30 mm

Cutting speed: 20–30 m/s

Rotational speed: 12,700–19,000 RPM

Drive roller dia. [mm]	Cutting speed [m/s]							
	5	10	15	20	25	30	35	40
20	4,700	9,500	14,300	19,000	23,800	28,600	33,400	38,100
30	3,100	6,300	9,500	12,700	15,900	19,000	22,200	25,400
40	2,300	4,700	7,100	9,500	11,900	14,300	16,700	19,000
50	1,900	3,800	5,700	7,600	9,500	11,400	13,300	15,200
80	1,100	2,300	3,500	4,700	5,900	7,100	8,300	9,500
100	900	1,900	2,800	3,800	4,700	5,700	6,600	7,600
120	700	1,500	2,300	3,100	3,900	4,700	5,500	6,300
160	500	1,100	1,700	2,300	2,900	3,500	4,100	4,700
200	400	900	1,400	1,900	2,300	2,800	3,300	3,800
250	300	700	1,100	1,500	1,900	2,200	2,600	3,000
300	300	600	900	1,200	1,500	1,900	2,200	2,500

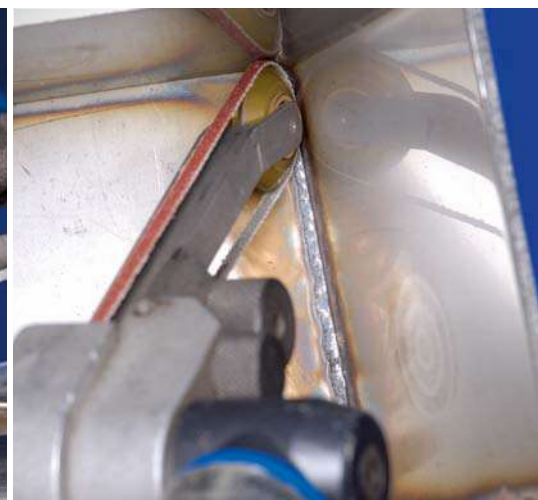

Manufacturer	Model	Abrasive belts' width/length [mm]	
PFERD	Compressed-air belt grinder		
	PBS 3/200 DH 99	BA 3/305	
	PWS 3/200 DH + BSVH 25.5	BA 6/305 BA 9/305 BA 12/305	
	PBSA 5/160 HV 925	BA 3/520	
		BA 6/520	
		BA 12/520	
		BA 16/520	
		BA 20/520	
		BA 6/610	
	PBS 5/155 HV	BA 12/610	
		BA 6/610	
		BA 10/480	
		BA 16/480	
		BA 20/480	
	Electric belt grinders	BA 25/480	
		BA 12/610	
		BA 3/520	
		BA 6/520	
		BA 12/520	
	UBS 5/100 SI 925	BA 16/520	
		BA 20/520	
		BA 6/610	
		BA 12/610	
		BA 12/610	
	Pipe belt grinders		
	UBS 5/70 SI-R	BA 30/533	
	UBS 11/90 SI-R	BA 30/610	
	BSG belt grinders for flexible shaft drives		
	BSG 10/35E	BA 35/450	
	BSG 10/50E	BA 50/450	
	Angle handpieces		
	WT 7 E M14 + BSVH 41	BA 3/520 BA 6/520	
WZ 7 B + BSVH 36	BA 12/520		
	BA 16/520		
	BA 20/520		
	BA 6/610		
WZ 10 B + BSVH 36	BA 12/610		
	BA 3/305		
	BA 6/305		
WZ 4 A + BSVH 24	BA 9/305		
	BA 12/305		
	BA 12/305		
3M	3M™ file belt sander	BA 13/457	
AEG	HBS 1000E	BA 75/533	
	BBSE 1100	BA 100/560	
Atlas Copco	G2403	BA 10/330	
	G2404	BA 20/520	
	G2410	BA 3-13/305	
ATA	RAL20L	BA 12/305	
	BL16L	BA 20/480	
Black & Decker	KA 88	BA 75/533	
	KA 900 E	BA 13/457	

Manufacturer	Model	Abrasive belts' width/length [mm]
Bosch	GBS 75 AE	BA 75/533
DeWalt	DW432	
	DW433	BA 75/533
	DWP352VS	
Dynabrade	40352	
	40353	
	40320	
	40321	
	40324	BA 13/457
	40335	
	40381	
	15300	
	15400	
	40326	BA 6-16/520
	40330	BA 13/457
	40615	BA 6/610
	40503	BA 12/610
	15360	
15420	BA 6/610	
14000	BA 12/610	
15401	BA 12-0/520	
15003	BA 3-12/305	
Einhell	RT-BS 75	BA 75/533
	BT-US 400	BA 100/920
Fein/Grit	GX 75 / 75 2H	
	GXC	
	GI 75 (2H) / GI 150 (2H)	BA 75/2000
	GIS 75	
	GIC	BA 75/2000 BA 150/2000
	GI 100 / 100 EF	BA 100/1000
	GIM	BA 150/2000
	GIL	
	GIS 150	BA 150/2000
	BF10-280E	BA 3-20/520
RS10-70E	BA 12-20/520 BA 30/533	
Festool	BS 75	BA 75/533
Flott	BSM 75 / 75A / 75A pol	BA 75/2000
	BSM 150 / 150A / 150A pol	BA 150/2000
	TBSM 75	BA 75/1000
Güde	BS 76-900 E	BA 75/533
	BTS 4000 ECO	
	BTS 4000	BA 100/920
Hitachi	SB10V2	BA 100/610

Manufacturer	Model	Abrasive belts' width/length [mm]	
Makita	9910		
	9911	BA 75/457	
	9902		
	9903	BA 75/533	
	9920	BA 75/610	
	9404		
	9403	BA 100/610	
	9031	BA 30/533	
	9032	BA 9/533	
	Metabo	BF 18 LTX 90	BA 13/457
RB 18 LTX 60		BA 30/533	
BFE 9-20		BA 13/457	
BAE 75		BA 75/533	
DBF 457		BA 13/457	
Milwaukee	BS 100 LE	BA 100/620	
	HBSE 75 S	BA 75/533	
Proxxon	BS/E	BA 10/330	
	BS/A	BA 10/330	
Rexon	BD480A		
	BD460M	BA 100/920	
Ryobi	EBS800V	BA 75/533	
	EBS1310VFHG	BA 100/610	
SCANTOOL	SC 75	BA 75/2000	
	SC 150	BA 150/2000	
Scheppach	BTS 800	BA 100/920	
SKIL	1215AA		
	1210AA	BA 75/457	
Suhner	UBK 6-R	BA 35-50/450	
	UTG 9-R	BA 30/610	
	UTC 7-R	BA 30/533	
	LBH 7 D 35	BA 35/450	
	LBH 7 D 50	BA 50/450	
	UBC 10-R		
	LBC 16 H	BA 6-12/520	
	WB 10		
	LBB 20 DH	BA 6/305 BA 12/305	
	FTM	BA 30/610	
	BSG 10/35	BA 35/450	
	BSG 10/50	BA 50/450	
	Triton	TA 1200BS	BA 75/533

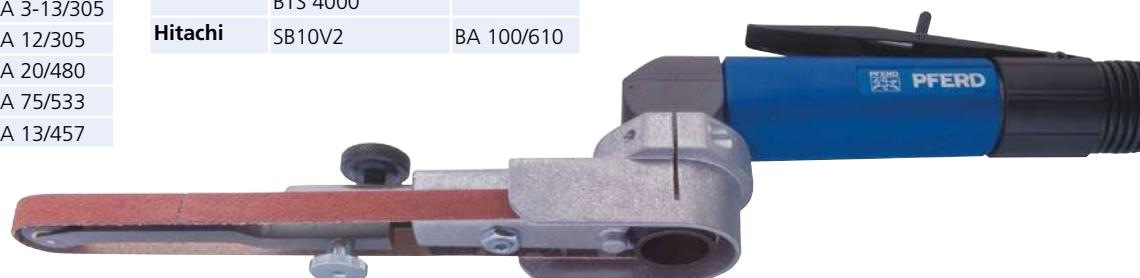

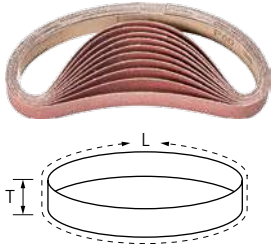

Aluminium oxide A type

For universal applications from coarse to fine grinding.

Abrasive:
Aluminium oxide A

Ordering notes:
■ Please complete the description with the desired grit size.

L [mm]	T [mm]	Grit size										Acc. to ISO stand- ards		Description
		40	50	60	80	100	120	180	240	320	400			
EAN 4007220														
305	3	-	-	663899	-	-	663912	-	-	-	-	-	100	BA 3/305 A ...
	6	-	-	664025	664032	-	-	664056	-	-	-	-	100	BA 6/305 A ...
	9	-	-	664179	664186	-	664193	664209	-	-	-	-	100	BA 9/305 A ...
	12	664261	-	664278	664285	-	664445	664292	-	-	-	-	100	BA 12/305 A ...
330	10	-	-	620151	620168	-	620182	620199	-	-	-	2976	100	BA 10/330 A ...
450	35	-	-	585665	-	585672	-	-	664704	664711	-	-	20	BA 35/450 A ...
	50	585719	-	585726	-	585733	-	-	664766	-	-	2976	20	BA 50/450 A ...
457	13	620267	-	620274	620298	-	620304	-	-	-	-	2976	100	BA 13/457 A ...
480	10	585542	-	585252	585269	-	585559	-	-	-	-	-	100	BA 10/480 A ...
	16	-	-	585368	-	-	585382	-	-	-	-	-	50	BA 16/480 A ...
	20	585610	664520	585429	585436	-	585443	664544	664551	-	-	2976	10	BA 20/480 A ...
	25	585634	-	585481	585498	-	585641	-	-	-	-	2976	20	BA 25/480 A ...
520	3	663950	-	663967	663974	-	663981	663998	664001	-	-	-	100	BA 3/520 A ...
	6	585528	-	585191	585207	-	585214	664124	664131	-	664155	2976	100	BA 6/520 A ...
	12	585573	-	585306	585313	-	585320	664322	664339	664346	664353	-	100	BA 12/520 A ...
	16	585603	-	585399	585405	-	585412	664407	-	-	-	-	50	BA 16/520 A ...
	20	585627	-	585450	585467	-	585474	664568	664575	-	-	2976	20	BA 20/520 A ...
533	30	620359	-	620380	620397	-	620410	664667	664674	664681	-	2976	20	BA 30/533 A ...
	75	584958	-	584965	584972	600429	584989	-	-	-	-	2976	10	BA 75/533 A ...
610	12	585580	-	585337	585344	-	585351	-	-	-	-	-	100	BA 12/610 A ...
	30	776414	-	776421	776438	-	776445	776452	776469	-	-	-	10	BA 30/610 A ...
	100	585030	-	585047	585054	600467	585061	-	-	-	-	2976	10	BA 100/610 A ...
920	100	620786	-	620793	620809	-	620823	-	-	-	-	-	10	BA 100/920 A ...

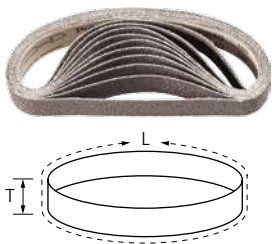

Aluminium oxide A compact grain type

Outstandingly suited to fine and very fine grinding, and for step-by-step preparations for polishing.

The self-sharpening compact grain facilitates a very long tool life and achieves consistent surface quality levels throughout the entire tool life.

Abrasive:
Aluminium oxide A compact grain

Ordering notes:
■ Please complete the description with the desired grit size.

L [mm]	T [mm]	Grit size										Acc. to ISO stand- ards		Description
		120	180	240	320	400	600	800	1000	1200				
EAN 4007220														
533	30	025925	025932	025949	025956	025963	025970	025987	025994	026007	10	BA 30/533 J A ... CK		
610	30	026014	026021	026038	026045	026052	026069	026076	026083	026090	10	BA 30/610 J A ... CK		

Zirconia alumina Z type

For coarse grinding work with a high stock removal rate and a long tool life.

Abrasive:
Zirconia alumina Z

Ordering notes:
■ Please complete the description with the desired grit size.

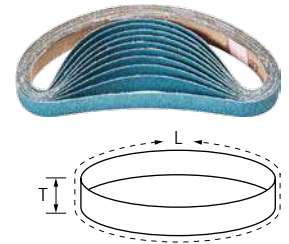

L [mm]	T [mm]	Grit size				Acc. to ISO standards		Description
		36	40	60	80			
EAN 4007220								
330	10	-	620205	620212	-	2976	100	BA 10/330 Z ...
	12	-	-	620236	620250	-	100	BA 12/330 Z ...
520	12	-	586273	586198	586204	-	100	BA 12/520 Z ...
	20	620342	586303	586259	586310	2976	20	BA 20/520 Z ...
610	12	-	586280	586211	586228	-	100	BA 12/610 Z ...

Aluminium oxide A-COOL type

For universal grinding work from fine to very fine grinding on materials which do not conduct heat well, e.g. stainless steel (INOX).

Active grinding additives in the coating substantially improve the stock removal rate, prevent clogging and result in cooler grinding.

Abrasive:
Aluminium oxide A-COOL

Ordering notes:
■ Please complete the description with the desired grit size.

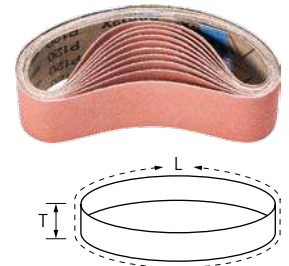

L [mm]	T [mm]	Grit size				Acc. to ISO standards		Description
		40	80	120	180			
EAN 4007220								
450	50	586099	586105	586112	586129	2976	20	BA 50/450 A-COOL ...

Ceramic oxide grain CO-COOL type

For aggressive grinding with the highest stock removal rates on hard materials which do not conduct heat well. Consistently high performance due to self-sharpening ceramic oxide grain.

Active grinding additives in the coating substantially improve the stock removal rate, prevent clogging and result in cooler grinding.

Abrasive:
Ceramic oxide grain CO-COOL

Ordering notes:
■ Please complete the description with the desired grit size.

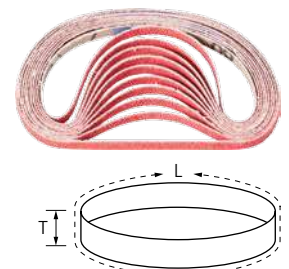

L [mm]	T [mm]	Grit size				Acc. to ISO standards		Description
		40	60	80	120			
EAN 4007220								
305	6	799215	799222	799239	799246	-	100	BA 6/305 CO-COOL ...
	9	799352	799369	799376	799383	-	100	BA 9/305 CO-COOL ...
	12	799444	799451	799468	799475	-	100	BA 12/305 CO-COOL ...
330	10	799390	799406	799413	799420	2976	100	BA 10/330 CO-COOL ...
	12	799482	799499	799505	799536	-	100	BA 12/330 CO-COOL ...
450	35	949887	949894	949917	949924	2976	20	BA 35/450 CO-COOL ...
	50	949931	949948	949955	949962	2976	20	BA 50/450 CO-COOL ...
457	13	799628	799635	799642	799659	2976	100	BA 13/457 CO-COOL ...
480	16	799666	799673	799680	799697	-	50	BA 16/480 CO-COOL ...
	20	799741	799758	799772	799789	2976	20	BA 20/480 CO-COOL ...

Continued on next page

Coated abrasives

Short belts BA



L [mm]	T [mm]	Grit size				Acc. to ISO standards		Description
		40	60	80	120			
		EAN 4007220						
480	25	799833	799840	799857	799864	2976	20	BA 25/480 CO-COOL ...
520	6	799260	799277	799284	799307	2976	100	BA 6/520 CO-COOL ...
	12	799543	799550	799567	799574	-	100	BA 12/520 CO-COOL ...
	16	799703	799710	799727	799734	-	50	BA 16/520 CO-COOL ...
	20	799796	799802	799819	799826	2976	20	BA 20/520 CO-COOL ...
533	30	799871	799888	799895	799901	-	20	BA 30/533 CO-COOL ...
610	6	799314	799321	799338	799345	2976	100	BA 6/610 CO-COOL ...
	12	799581	799598	799604	799611	-	100	BA 12/610 CO-COOL ...
	30	799918	799925	799932	799949	-	10	BA 30/610 CO-COOL ...

Short belts VB

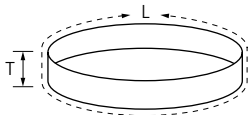

Non-woven type

Suitable for universal work on surfaces such as metal tubular structures, e.g. removal of rough grinding traces, removal of oxidation and light deburring work. Achieve matt and satin-finished surfaces.

Abrasive:

Aluminium oxide A
Available POLIVLIES grit sizes:
100 G = coarse (yellow-brown)
180 M = medium (red-brown)
240 F = fine (blue)

Recommendations for use:

■ For the best results, use at a recommended cutting speed of 5–15 m/s.

Ordering notes:

■ Please complete the description with the desired grit size.

L [mm]	T [mm]	Grit size			Acc. to ISO standards		Description
		100 G	180 M	240 F			
		EAN 4007220					
305	6	667552	667569	667545	-	10	VB 6/305 A ...
	9	667668	667675	667620	-	10	VB 9/305 A ...
	12	667637	667644	667651	-	10	VB 12/305 A ...
450	35	586631	586648	586655	-	10	VB 35/450 A ...
	50	586662	586679	586686	2976	10	VB 50/450 A ...
520	6	586518	586525	586532	-	10	VB 6/520 A ...
	12	586549	586556	586563	-	10	VB 12/520 A ...
	16	586570	586587	586594	-	10	VB 16/520 A ...
	20	586600	586617	586624	2976	5	VB 20/520 A ...
533	30	667699	667705	667682	2976	5	VB 30/533 A ...
610	6	101063	101070	101087	2976	10	VB 6/610 A ...
	12	101117	101124	101131	-	10	VB 12/610 A ...
	30	776520	776537	776551	-	5	VB 30/610 A ...

Felt type

Suitable for polishing with polishing paste bars and grinding pastes on tubular constructions and rails.

Recommendations for use:

- For the polishing process, apply pre-polishing and high-gloss polishing successively.
- When changing the polishing paste, also replace the polishing belt in order not to introduce any contaminants from the previous work step.
- For the best results, use at a recommended cutting speed of 5–15 m/s.

Accessories:

- Grinding and polishing pastes

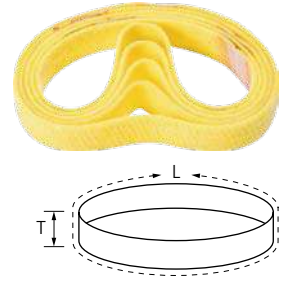

L [mm]	T [mm]	EAN 4007220	Acc. to ISO standards		Description
533	30	936269	2976	5	P-BA 30/533
610	30	936276	-	5	P-BA 30/610

Set BA

Belt grinder set BA

Set of different short belts, including electric belt grinder, for universal work on surfaces from coarse to fine, especially for assembly work.

Contents:

- Electric belt grinder UBS 5/100 SI 925 with continuous rotational speed control from 6.5–16 m/s, output 500 watts
- 2 pcs. each of abrasive belts, width 6 and 12 mm, in aluminium oxide A type, grain 40, 60, 80, 120 and 180
- 2 pcs. each of non-woven belts (6 and 12 mm wide) in coarse, medium and fine

Advantages:

- Optimal, stepless rotational speed regulation for the use of high-speed abrasive belts and low-speed non-woven belts.
- Coordinated selection of the most common versions.

Abrasive:

Aluminium oxide A

Recommendations for use:

- Use abrasive belts at the higher rotational speed levels 4–6 (7,000–10,000 RPM = 11–16 m/s).
- Use non-woven belts at the lower rotational speed levels 1–4 (4,000–7,000 RPM = 6–11 m/s).

Ordering notes:

- Detailed information and ordering data on tool drives can be found in catalogue section 9.

Safety notes:

- The maximum peripheral speed for abrasive belts is 32 m/s.
- The maximum peripheral speed for non-woven belts is 25 m/s.



L [mm]	EAN 4007220		Description
520	344125	1	SET BA 6-12/520 UBS 5/100 230 V



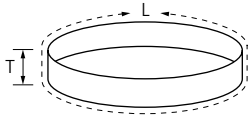

Aluminium oxide A type

For universal applications from coarse to fine grinding.

Abrasive:
Aluminium oxide A

Ordering notes:
■ Please complete the description with the desired grit size.

L [mm]	T [mm]	Grit size					Acc. to ISO stand- ards		Description
		36	40	60	80	120			
		EAN 4007220							
1,000	50	-	-	621059	621066	621073	2976	10	BA 50/1000 A ...
	100	-	585917	585924	585931	585948	2976	10	BA 100/1000 A ...
2,000	50	-	585771	585788	585795	585801	2976	10	BA 50/2000 A ...
	75	600481	585832	585849	585856	585863	2976	10	BA 75/2000 A ...
	150	600597	585955	585962	585979	-	2976	10	BA 150/2000 A ...
2,500	75	620373	585870	585887	585894	585900	2976	10	BA 75/2500 A ...

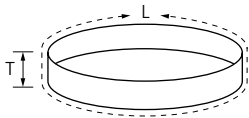

Zirconia alumina Z type

For coarse grinding work with a high stock removal rate and a long tool life.

Abrasive:
Zirconia alumina Z

Ordering notes:
■ Please complete the description with the desired grit size.

L [mm]	T [mm]	Grit size					Acc. to ISO stand- ards		Description	
		24	36	40	60	80				120
		EAN 4007220								
1,000	100	-	-	586457	586464	586471	621042	2976	10	BA 100/1000 Z ...
2,000	50	621219	621233	586327	586334	586341	619353	2976	10	BA 50/2000 Z ...
	75	600511	586358	586365	586372	586389	586396	2976	10	BA 75/2000 Z ...
	150	-	600641	586488	586495	586501	600672	2976	10	BA 150/2000 Z ...
2,250	75	-	-	613191	613214	-	-	2976	10	BA 75/2250 Z ...
2,500	75	-	586402	586419	586426	586433	-	2976	10	BA 75/2500 Z ...
	150	-	621141	-	-	-	-	2976	10	BA 150/2500 Z ...

Zirconia alumina Z-FORTE type

For coarse grinding work with a high stock removal rate, a long tool life and very cool grinding. Particularly suitable for work on thin-walled stainless steel (INOX) components and on steels or nickel-based alloys which do not conduct heat well.

Abrasive:
 Zirconia alumina Z-FORTE

Ordering notes:
 ■ Please complete the description with the desired grit size.

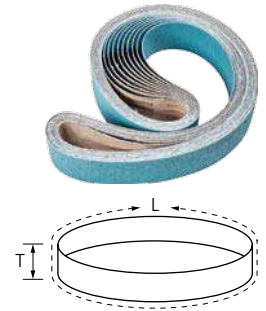

L [mm]	T [mm]	Grit size				Acc. to ISO standards		Description
		36 FORTE	40 FORTE	60 FORTE	80 FORTE			
EAN 4007220								
2,000	75	620175	620243	620311	620335	2976	10	BA 75/2000 Z ...
2,500	75	620458	620502	-	-	2976	10	BA 75/2500 Z ...

Ceramic oxide grain CO type

For aggressive grinding with a very high stock removal rate and very long tool life. Consistently high performance due to self-sharpening ceramic oxide grain. The ceramic oxide grain is specifically designed for work on hard materials and layers.

Abrasive:
 Ceramic oxide grain CO

Ordering notes:
 ■ Please complete the description with the desired grit size.

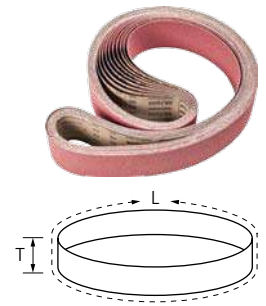

L [mm]	T [mm]	Grit size						Acc. to ISO standards		Description	
		24	36	40	50	60	80				120
EAN 4007220											
2,000	50	950623	950630	950647	950654	950661	950678	950685	2976	10	BA 50/2000 CO ...
	75	950692	950708	950715	950722	950739	950746	950753	2976	10	BA 75/2000 CO ...
2,500	75	950760	950777	950784	950791	950807	950814	950821	2976	10	BA 75/2500 CO ...

Ceramic oxide grain CO-COOL type

For aggressive grinding with the highest stock removal rates on hard materials which do not conduct heat well. Consistently high performance due to self-sharpening ceramic oxide grain. Active grinding additives in the coating substantially improve the stock removal rate, prevent clogging and result in cooler grinding.

Abrasive:
 Ceramic oxide grain CO-COOL

Ordering notes:
 ■ Please complete the description with the desired grit size.

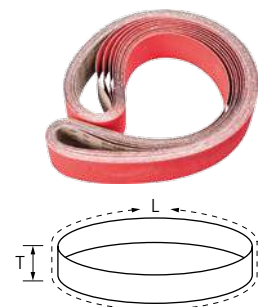

L [mm]	T [mm]	Grit size					Acc. to ISO standards		Description	
		36	40	50	60	80				120
EAN 4007220										
2,000	50	950173	950333	950357	950371	950401	950425	2976	10	BA 50/2000 CO-COOL ...
	75	950449	950470	950494	950500	950517	950524	2976	10	BA 75/2000 CO-COOL ...
2,500	75	950562	950579	950586	950593	950609	950616	2976	10	BA 75/2500 CO-COOL ...

Coated abrasives

Long belts BA

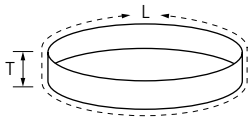

Non-woven type

Suitable for universal work on metal surfaces in stationary applications, e.g. removal of rough grinding traces, removal of oxidation and light deburring work. Achieve matt and satin-finished surfaces.

Abrasive:

Aluminium oxide A

Available POLIVLIES grit sizes:

100 G = coarse (yellow-brown)

180 M = medium (red-brown)

240 F = fine (blue)

Recommendations for use:

- For the best results, use at a recommended cutting speed of 5–15 m/s.

Ordering notes:

- Please complete the description with the desired grit size.

L [mm]	T [mm]	Grit size				Description
		100 G	180 M	240 F		
		EAN 4007220				
2,000	75	066164	066188	066195	2	VB 75/2000 A ...
2,500	75	066225	066232	066249	2	VB 75/2500 A ...



Brown BR type

The brown cloth-backed variant is suitable for universal, heavy-duty use on alloyed and non-alloyed steels, as well as non-ferrous metals.

The cloth-backed abrasive sheets comply with ISO 21948.

Advantages:

- Very high grain adhesion on very flexible cloth.
- High abrasive performance.
- Oil and kerosene-resistant.

Recommendations for use:

- Tear to the necessary size if required.

Ordering notes:

- Please complete the description with the desired grit size.

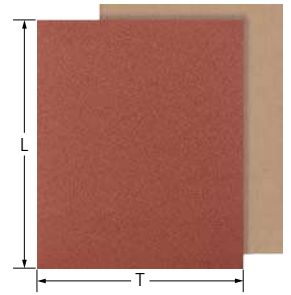

Abrasive:

Aluminium oxide A

L [mm]	T [mm]	Grit size							Description	
		40	60	80	100	120	150	180		
		EAN 4007220								
280	230	587393	587409	587416	587423	587430	587447	587454	50	BG BR 230x280 A ...

L [mm]	T [mm]	Grit size						Description		
		220	240	280	320	400	444		999	
		EAN 4007220								
280	230	587461	587478	587485	587492	587515	587522	587539	50	BG BR 230x280 A ...

Blue BL type

The blue cloth-backed variant is the low-cost alternative for normal workloads when working on painted wooden and metal surfaces.

The cloth-backed abrasive sheets comply with ISO 21948.

Advantages:

- Good grain adhesion on sturdy cloth.
- Good abrasive performance.

Recommendations for use:

- Tear to the necessary size if required.

Ordering notes:

- Grit sizes 40, 60 and 80 are supplied in packaging units of 50 pieces.
- Please complete the description with the desired grit size.

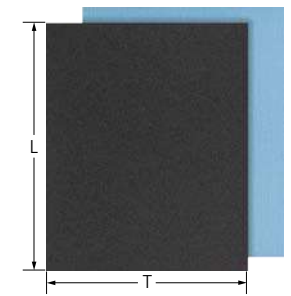

Abrasive:

Aluminium oxide A

L [mm]	T [mm]	Grit size									Description	
		40	60	80	100	120	150	180	220	240		
		EAN 4007220										
280	230	587270	587287	587294	587300	587317	587324	587331	587348	587355	100	BG BL 230x280 A ...

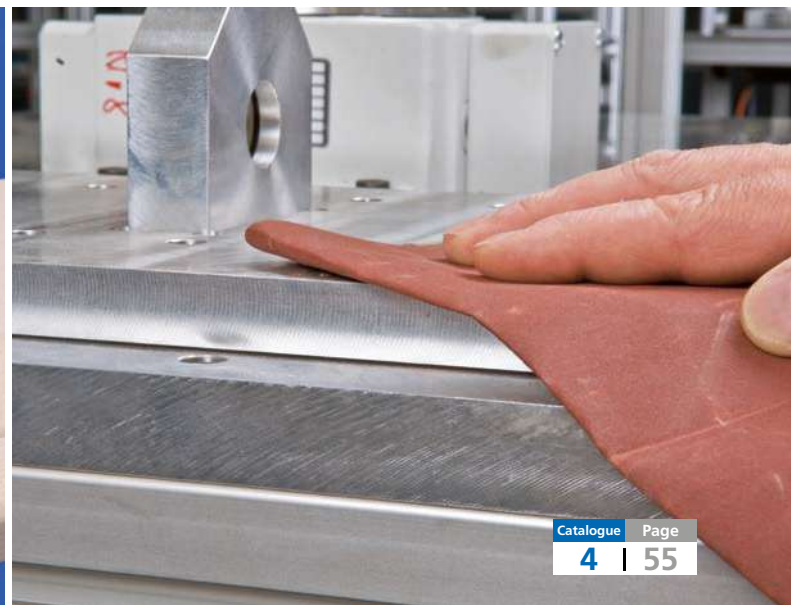

Coated abrasives

Paper-backed abrasive sheets BP

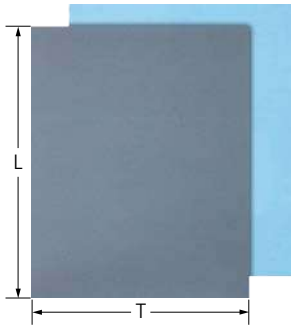

SiC type, waterproof W

The SiC abrasive enables use on paint and glass. Particularly suitable for all wet grinding work on conventional painted constructions.

The paper-backed abrasive sheets comply with ISO 21948.

Advantages:

- Very high grain adhesion on very flexible and light paper.
- Maximum abrasive performance.
- Can be used for wet and dry grinding.

Recommendations for use:

- Tear to the necessary size if required.

Ordering notes:

- Please complete the description with the desired grit size.

Abrasive:

Silicon carbide SiC

L [mm]	T [mm]	Grit size									Description
		100	120	150	180	220	240	280	320		
EAN 4007220											
280	230	587546	588222	588239	588246	588253	588260	588277	588284	50	BP W 230x280 SiC ...

L [mm]	T [mm]	Grit size							Description	
		360	400	500	600	800	1000			1200
EAN 4007220										
280	230	588291	588307	588314	588321	588338	588345	588352	50	BP W 230x280 SiC ...

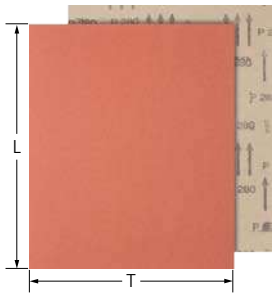

Aluminium oxide A type

The aluminium oxide A abrasive is the low-cost alternative for normal workloads when working on painted wooden and metal surfaces.

The paper-backed abrasive sheets comply with ISO 21948.

Advantages:

- Good grain adhesion on sturdy paper.
- Good abrasive performance.

Recommendations for use:

- Tear to the necessary size if required.

Ordering notes:

- Grit sizes 40, 60 and 80 are supplied in packaging units of 50 pieces.
- Please complete the description with the desired grit size.

Abrasive:

Aluminium oxide A

L [mm]	T [mm]	Grit size												Description
		40	60	80	100	120	150	180	220	240	280	400		
EAN 4007220														
280	230	622520	622544	622551	622568	622575	622582	622476	622483	622490	622506	622513	100	BP 230x280 A ...



POLINOX hand pads PVSK

Suitable for very fine grinding on small to large surfaces and contours, and for manually cleaning metal and painted surfaces. Achieve matt and satin-finished surfaces. Highly open structure.

Advantages:

- Highly flexible, enabling optimal adjustment to the contour.
- Hard-to-reach areas can be accessed.
- Can be used for wet and dry grinding.

Recommendations for use:

- Cut to the necessary size if required.

Ordering notes:

- Please complete the description with the desired grit size.

Abrasive:

Aluminium oxide A
Silicon carbide SiC

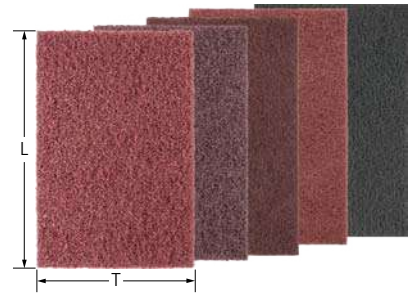

L [mm]	T [mm]	Abrasives	Grit size						Description
			80	100	180	280	400		
			EAN 4007220						
224	154	A	294611	294628	294635	294642	-	10	PVSK 150 A ...
		SiC	-	-	-	-	294659	10	PVSK 150 SiC ...

HP diamond type

Exceptionally suitable for work on wear-resistant coatings and for hard facings made of tungsten carbide, chromium carbide, titanium carbide, etc. Particularly recommended for work on materials used for aircraft engine construction, e.g. Hastelloy, Inconel and titanium/titanium alloys. Also highly suitable for work on extremely hard materials such as tungsten carbide, glass, ceramics, enamel, stone and GRP/CRP.

Advantages:

- Highly flexible, enabling optimal adjustment to the contour.
- Hard-to-reach areas can be accessed.
- Can be used for wet and dry grinding.

Recommendations for use:

- Work with little contact pressure.

Ordering notes:

- Grit sizes are indicated in µm.
- Further information on diamond grinding tools can be found in catalogue section 5.
- Please complete the description with the desired grit size.

Abrasive:

Diamond
D 251 (green) = P 60
D 126 (black) = P 120
D 76 (red) = P 200
(P = Grit size according to ISO 6344)

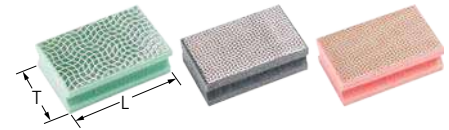

L [mm]	T [mm]	Grit size [µm]				Description
		251	126	76		
		EAN 4007220				
90	55	804568	804575	804582	1	HP 5590 DIA ...



Coated abrasives

General information – Shop rolls

Thanks to their high flexibility, shop rolls are ideally suited to a range of grinding applications. The matching shop roll holder is suitable for storing and tearing off the belts to the required length.

Advantages:

- Optimum adaptation to contours thanks to high flexibility.
- Low wear thanks to high tear strength and very high grain adhesion.

Applications:

- Roughening
- Surface work
- Cleaning
- Step-by-step fine grinding

Recommendations for use:

- Cut to the required dimensions if necessary.

Matching tool drives:

- Manual application

Ordering notes:

- Please order shop roll holders separately.
- When ordering, please state the EAN or the full description.
- **Ordering example:**
EAN 4007220**587775**
SBR 50 A **100**
- **Ordering example explanation:**
SBR = Shop rolls
50 = Width T [mm]
A = Abrasive
100 = Grit size



Accessories:

- Shop roll holders

Shop rolls SBR



Cloth, aluminium oxide A type

The brown cloth-backed variant is suitable for universal, heavy-duty use on alloyed and non-alloyed steels, as well as non-ferrous metals. The carton has a tear-off edge for separating the sections of abrasive belt at the workplace.

SBR 25, SBR 40 and SBR 50 correspond to shape B, ISO 3366.
SBR 100 corresponds to shape A, ISO 3366.

Abrasive:

Aluminium oxide A

Ordering notes:

- Please complete the description with the desired grit size.

Length [m]	T [mm]	D [mm]	Grit size								Description
			40	50	60	80	100	120	150		
EAN 4007220											
25	38	75.0	602010	602027	602034	602041	602058	602065	602072	1	SBR 38 A ...
50	25	75.0	-	-	587553	587560	587577	587584	587591	1	SBR 25 A ...
	40	75.0	587645	-	587652	587669	587676	587683	587690	1	SBR 40 A ...
	50	75.0	587744	-	587751	587768	587775	587782	587799	1	SBR 50 A ...
	100	75.0	587843	-	587850	588864	587874	587881	587973	1	SBR 100 A ...

Length [m]	T [mm]	D [mm]	Grit size								Description
			180	220	240	320	400	600	800		
EAN 4007220											
25	38	75.0	602089	602096	602102	602119	602126	-	-	1	SBR 38 A ...
50	25	75.0	587607	-	587614	587621	587638	607237	607244	1	SBR 25 A ...
	40	75.0	587706	622612	587713	587720	587737	-	-	1	SBR 40 A ...
	50	75.0	587805	621981	587812	587829	587836	607251	-	1	SBR 50 A ...
	100	75.0	587980	-	587997	588000	588017	-	-	1	SBR 100 A ...

Paper, aluminium oxide A type

The abrasive material aluminium oxide A is the low-cost alternative for normal workloads when working on painted wooden and metal surfaces.

Abrasive:
Aluminium oxide A

Ordering notes:
■ Please complete the description with the desired grit size.

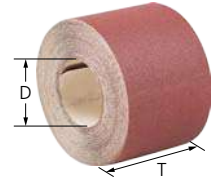

Length [m]	T [mm]	D [mm]	Grit size					Description		
			40	60	80	100	120		150	
			EAN 4007220							
25	115	75.0	667774	667781	622858	622865	667798	667804	1	SBR-P 115 A ...

Shop roll holder SRH

SRH 1 and SRH 5 types

Holder for wall-mounting: for storing and tearing off to the required length as necessary. With the variant SRH 5, various roll sizes can be combined with each other as desired.

Advantages:
■ Enable shop rolls to be stored correctly.

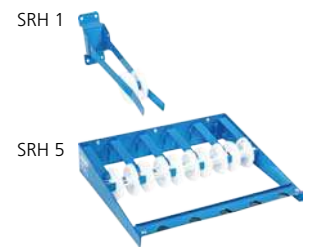

No. of rolls	Suitable for roll widths [mm]	Suitable for roll dia. [mm]	EAN 4007220	Description
1	25, 38, 40, 50	380	297551	SRH 1
5	25, 38, 40, 50	260	297568	SRH 5

POLINOX non-woven shop rolls VBR

Aluminium oxide A and silicon carbide SiC types

Suitable for very fine grinding on small to large surfaces and contours, and for manually cleaning metal and painted surfaces. Achieve matt and satin-finished surfaces. Highly open structure.

Advantages:
■ Highly flexible, enabling optimal adjustment to the contour.
■ Hard-to-reach areas can be accessed.
■ Can be used for wet and dry grinding.

Recommendations for use:
■ Cut to the necessary size if required.

Ordering notes:
■ Please complete the description with the desired grit size.

Abrasive:
Aluminium oxide A
Silicon carbide SiC



Length [m]	T [mm]	Abrasives	Grit size					Description	
			80	100	180	280	400		
			EAN 4007220						
10	100	A	095690	622711	622728	622735	-	1	VBR 100 A ...
		SiC	-	-	-	-	951385	1	VBR 100 SiC ...



SS type

High flexibility, therefore ideal for very fine deburring and finishing work in hard-to-reach places. Especially recommended for work on very small holes, grooves and cut-outs in tool- and mould-making.

Explanation of the abbreviations:

D = Abrasive cord diameter

Abrasive:

Aluminium oxide A

Silicon carbide SiC

Ordering notes:

■ Please complete the description with the desired grit size.

D [mm]	Length [m]	Grit size				EAN 4007220	Description
		120	150	180	200		
Aluminium oxide A							
0.8	15	-	-	-	037614	1	SS 0,8mm x 15m A ...
1	15	-	-	037638	-	1	SS 1,0mm x 15m A ...
1.4	15	-	037645	-	-	1	SS 1,4mm x 15m A ...
1.8	15	-	-	037652	-	1	SS 1,8mm x 15m A ...
2.1	15	037676	-	-	-	1	SS 2,1mm x 15m A ...
Silicon carbide SiC							
0.5	15	-	-	-	037607	1	SS 0,5mm x 15m SiC ...

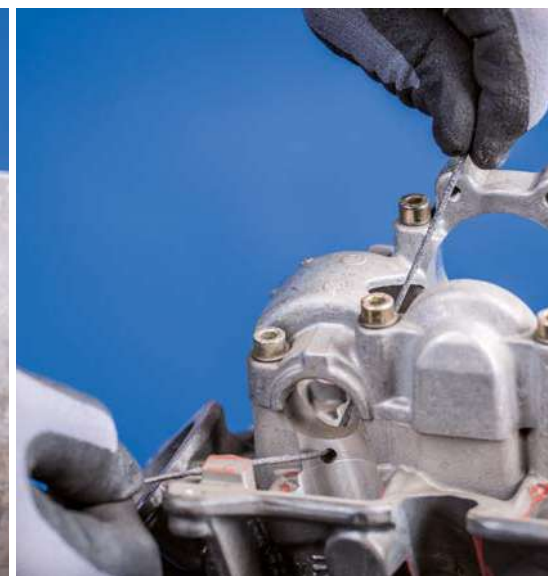

Velcro-backed abrasive discs are suitable for fine-grinding large surfaces using eccentric orbital sanders and can be universally used on metal, wood, plastic and paintwork.

The velcro-backed abrasive discs with extraction holes are realized in shape A in compliance with ISO 21951:

O L: Without extraction holes

Dia. 125 8 L: 8 extraction holes, dia. 10 mm, reference circle 65 mm, ISO 21951 – nominal size 6

Dia. 150 8 L: 8 extraction holes, dia. 10 mm, reference circle 65 mm, ISO 21951 – nominal size 9

Dia. 150 6 L: 6 extraction holes, dia. 10 mm, reference circle 80 mm, ISO 21951 – nominal size 10

Advantages:

- High profitability thanks to quick tool changes and high abrasive performance.
- Longest possible tool life thanks to low clogging.

Applications:

- Roughening
- Surface work
- Cleaning
- Step-by-step fine grinding

Matching tool drives:

- Eccentric orbital sanders

Ordering notes:

- When ordering, please state the EAN or the full description.

■ **Ordering example:**
EAN 4007220599297
KSS 125 8 L A 60

- **Ordering example explanation:**
KSS = Velcro-backed abrasive disc
125 = Diameter
8 L = 8 extraction holes
A = Abrasive
60 = Grit size

Safety notes:



Velcro-backed abrasive discs KSS

Aluminium oxide A type

For universal grinding work from coarse to fine grinding in industry and professional trades.

Abrasive:

Aluminium oxide A

Ordering notes:

- Please complete the description with the desired grit size.

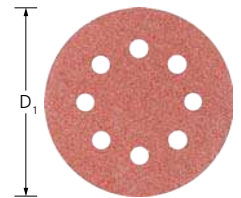

D ₁ [mm]	Holes	Grit size										Description	
		40	60	80	100	120	150	180	240	320	400		
EAN 4007220													
125	0	599273	599297	599303	599310	599426	599327	-	-	-	-	25	KSS 125 O L A ...
	8	588024	588031	588048	588055	588062	588079	588086	588093	588109	588116	25	KSS 125 8 L A ...
150	0	599341	599358	599365	599372	599389	599396	599402	599419	-	-	25	KSS 150 O L A ...
	8	599105	599112	599129	599136	599143	599150	-	-	-	-	25	KSS 150 8 L A ...
	6	588123	588130	588147	588154	588161	588178	588185	588192	588208	588215	25	KSS 150 6 L A ...



Coated abrasives

General information – Velcro-backed abrasive discs KSS-NET

Velcro-backed abrasive discs in the NET type feature a netting fabric, to which the abrasive grain is bonded with a high-performance bond system, which makes it very durable.

The range comprises various diameters that have been adapted to the drives common on the market, and also a comprehensive choice of grains, from 80 to 1,000.

Advantages:

- Very long tool life and high stock removal rate.
- Very fine, even surfaces can be achieved.
- Dust-free work thanks to good extraction capability.
- No clogging thanks to netting structure.
- Durable netting structure with high tear strength and edge stability.

Materials that can be worked:

- Aluminium
- Additional non-ferrous metals
- Stainless steel (INOX)
- Wood
- Plastics
- Steel, cast steel

Applications:

- Roughening
- Surface grinding
- Cleaning
- Step-by-step fine grinding

Matching tool drives:

- Eccentric orbital sanders

Ordering notes:

- When ordering, please state the EAN or the full description.

■ **Ordering example:**
 EAN 4007220**105207**
 KSS NET 125 A **80**

■ **Ordering example explanation:**
 KSS NET = Velcro-backed abrasive disc,
 NET type
 125 = Diameter
 A = Abrasive
 80 = Grit size

Safety notes:



Velcro-backed abrasive discs KSS-NET



KSS-NET type

For dust-free, universal grinding work on medium-sized and large surfaces.

Abrasive:

Aluminium oxide A

Recommendations for use:

- Use the extraction connection on the machine to effectively remove the grinding dust.

Ordering notes:

- Please complete the description with the desired grit size.

D ₁ [mm]	Grit size												Description
	80	100	120	150	180	240	320	400	600	800	1000		
	EAN 4007220												
125	105207	105214	105221	105238	105245	105252	105269	105276	105283	105290	105306	25	KSS NET 125 A ...
150	105313	105320	105337	105344	105351	105368	105375	105382	105399	105405	105412	25	KSS NET 150 A ...



The comprehensive range of abrasive spiral bands offers the best tool solution for every application, from fine grinding through to aggressive grinding.

Matching, reusable rubber drum holders in two different shapes are available for using abrasive spiral bands:

- Cylindrical
- Conical

In ISO 2421, abrasive spiral bands are designated as "cylindrical abrasive sleeves".

In ISO 15637-1, cylindrical rubber drum holders are designated as "holding fixtures for cylindrical abrasive sleeves".

KSB = Small pack of abrasive spiral bands

GSB = Bulk pack of abrasive spiral bands

Advantages:

- Abrasive spiral band fits securely on the rubber drum holder as the holder expands during use.
- Outstanding tool life thanks to special manufacturing process – even under the toughest work conditions.
- Highest possible profitability thanks to particularly high stock removal and aggressiveness of the abrasive.

Applications:

- Roughening
- Levelling
- Deburring
- Surface work
- Work on edges
- Sharpening
- Work on weld seams
- Step-by-step fine grinding

Recommendations for use:

- To change the abrasive spiral bands easily, raise and lower them while turning slightly to the right. When doing so, leave the rubber drum holder engaged in the tool drive.
- Adhere to the minimum speed for the rubber drum holder to ensure that the abrasive spiral band fits securely.
- For best performance, use with a recommended cutting speed of 20–30 m/s.
- Use grinding oil which is suitable for the material in order to considerably increase the tool life and abrasive performance of the tools. More detailed information and ordering data for grinding oils can be found on page 155.

Matching tool drives:

- Flexible shaft drives
- Straight grinders

Ordering notes:

- Please order rubber drum holders separately.
- When ordering, please state the EAN or the full description.

Ordering example:

EAN 4007220**148426**

GSB 4530 Z-COOL **36**

Ordering example explanation:

GSB = Bulk pack of abrasive spiral bands

4530 = Inner diameter D x width T [mm]

Z = Abrasive

COOL = Bond type

36 = Grit size

Safety notes:

- The maximum permitted peripheral speed is 30 m/s.
- For safety reasons, the specified maximum permitted rotational speed must never be exceeded.
- Do not allow abrasive spiral bands to protrude beyond the rubber drum holder.



Accessories:

- Rubber drum holder



Recommended rotational speed range

Example:

KSB 4530 A 60

Cutting speed: 20–30 m/s

Rotational speed: 8,400–12,700 RPM

Tool dia. [mm]	Cutting speed [m/s]		
	20	25	30
	Rotational speeds [RPM]		
4	95,400	119,300	143,200
6	63,600	79,500	95,400
8	47,700	59,600	71,600
10	38,100	47,700	57,200
13	29,300	36,700	44,000
15	25,400	31,800	38,100
19	20,100	25,100	30,100
22	17,300	21,700	26,000
25	15,200	19,000	22,900
30	12,700	15,900	19,000
38	10,000	12,500	15,000
45	8,400	10,600	12,700
51	7,400	9,300	11,200
60	6,300	7,900	9,500
75	5,000	6,300	7,600
100	3,800	4,700	5,700

Abrasive spiral bands

General information

The fast way to the best tool

Material group ▼			Abrasive ▶	Aluminium oxide A	Zirconia alumina Z	Zirconia alumina Z-COOL	Ceramic oxide grain CO-COOL	Silicon carbide SiC
Steel, cast steel	Non-hardened, non-heat-treated steels	Construction steels, carbon steels, tool steels, non-alloyed steels, cast steel	●	○			●	
	Hardened, heat-treated steels	Tool steels, tempering steels, alloyed steels, cast steel	○	●			●	
Stainless steel (INOX)	Rust- and acid-resistant steels	Austenitic and ferritic stainless steels		○	●	●		
Non-ferrous metals	Soft non-ferrous metals, non-ferrous metals	Soft aluminium alloys	○		○	○		
		Brass, copper, zinc	●	○	○			
	Hard non-ferrous metals	Hard aluminium alloys	●	○	○		○	
		Bronze, titanium		○	●	●	●	
	High-temperature-resistant materials	Nickel-based and cobalt-based alloys		○	●	●		
Cast iron	Grey cast iron, white cast iron	Cast iron with flake graphite EN-GJL (GG), with nodular graphite/nodular cast iron EN-GJS (GGG), white annealed cast iron EN-GJMW (GTW), black cast iron EN-GJMB (GTS)	●	○				
Plastics, other materials		Fibre-reinforced plastics, thermoplastics, wood, chipboard, paintwork	●					●

● = Highly suitable

○ = Suitable

Small pack KSB

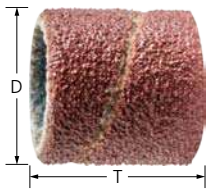

Aluminium oxide A type

For universal applications from coarse to fine grinding.

Abrasive:
Aluminium oxide A

Ordering notes:

■ Please complete the description with the desired grit size.

D [mm]	T [mm]	Grit size						Opt. RPM		Description
		40	50	60	80	150	240			
EAN 4007220										

Cylindrical shape

10	10	-	-	-	148921	148938	-	30,000–44,000	25	KSB 1010 A ...
	20	-	-	-	148952	148969	148976	30,000–44,000	25	KSB 1020 A ...
13	10	-	-	-	148983	148990	-	30,000–44,000	25	KSB 1310 A ...
	25	-	-	-	149010	149027	-	30,000–44,000	25	KSB 1325 A ...
15	10	-	-	149041	149058	149065	-	26,000–36,000	25	KSB 1510 A ...
	30	-	149089	149096	149102	149119	149126	26,000–36,000	25	KSB 1530 A ...
19	25	-	-	149133	149140	149157	149164	20,000–30,000	25	KSB 1925 A ...
22	20	-	149171	149188	149195	149201	-	18,000–26,000	25	KSB 2220 A ...
25	25	-	-	149225	149232	149249	-	16,000–22,900	25	KSB 2525 A ...
30	20	149263	-	149270	149287	149294	-	13,000–19,100	25	KSB 3020 A ...
	30	149324	149317	149331	149348	149355	-	13,000–19,100	25	KSB 3030 A ...
38	25	149379	-	149386	149393	149409	-	10,000–15,900	25	KSB 3825 A ...
45	30	149461	149454	149478	149485	149492	-	8,500–12,700	10	KSB 4530 A ...
51	25	149515	-	149522	149539	149546	-	7,500–11,200	10	KSB 5125 A ...
60	30	149577	149560	149584	149591	149607	-	6,500–9,500	10	KSB 6030 A ...
75	30	149614	-	149621	149638	149645	-	5,000–7,600	10	KSB 7530 A ...

Aluminium oxide A type

For universal applications from coarse to fine grinding.

Abrasive:
Aluminium oxide A

Ordering notes:
■ Please complete the description with the desired grit size.

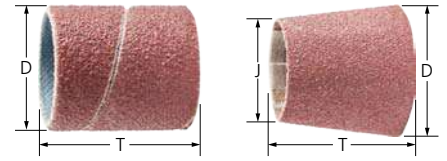

D [mm]	J [mm]	T [mm]	Grit size					Opt. RPM		Description
			40	50	60	80	150			

EAN 4007220

Cylindrical shape

4	-	10	-	-	-	-	147610	-	30,000–55,000	100	GSB 0410 A ...
6	-	10	-	-	-	-	147634	-	30,000–55,000	100	GSB 0610 A ...
8	-	10	-	-	-	-	147658	-	30,000–55,000	100	GSB 0810 A ...
10	-	10	-	-	-	147672	147689	-	30,000–44,000	100	GSB 1010 A ...
		20	-	-	949740	147702	147719	147726	30,000–44,000	100	GSB 1020 A ...
13	-	10	-	-	-	147733	147740	-	30,000–44,000	100	GSB 1310 A ...
		25	-	-	-	147764	147771	-	30,000–44,000	100	GSB 1325 A ...
15	-	10	-	-	147795	147801	147818	-	26,000–36,000	100	GSB 1510 A ...
		30	-	147832	147849	147856	147863	147870	26,000–36,000	100	GSB 1530 A ...
19	-	25	-	-	147931	147948	147955	-	20,000–30,000	100	GSB 1925 A ...
22	-	20	-	147979	147986	147993	148006	148013	18,000–26,000	100	GSB 2220 A ...
25	-	25	-	-	148075	148082	148099	-	16,000–22,900	100	GSB 2525 A ...
30	-	20	148112	-	148129	148136	148143	-	13,000–19,100	100	GSB 3020 A ...
		30	148174	148167	148181	148198	148204	148211	13,000–19,100	100	GSB 3030 A ...
38	-	25	148280	-	148297	148303	148310	-	10,000–15,900	100	GSB 3825 A ...
45	-	30	148372	148365	148389	148396	148402	148419	8,500–12,700	100	GSB 4530 A ...
51	-	25	148488	-	148495	148501	148518	-	7,500–11,200	100	GSB 5125 A ...
60	-	30	148549	148532	148556	148563	148570	-	6,500–9,500	100	GSB 6030 A ...
75	-	30	148648	-	148655	148662	148679	-	5,000–7,600	100	GSB 7530 A ...
100	-	40	148686	-	148693	148709	148716	-	4,000–5,700	50	GSB 10040 A ...

Conical shape

20	14	63	148723	-	148730	148747	148754	148761	19,000–26,000	100	GSB 201463 A ...
29	22	30	148778	-	148785	148792	148808	-	13,000–19,100	100	GSB 292230 A ...
36	22	60	148822	-	148839	148846	148853	-	10,000–15,900	100	GSB 362260 A ...



Abrasive spiral bands

Bulk pack GSB

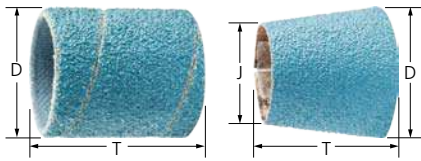

Zirconia alumina Z type

For coarse grinding work with a high stock removal rate and a long tool life.

Abrasive:
Zirconia alumina Z

Ordering notes:

- Please complete the description with the desired grit size.

D [mm]	J [mm]	T [mm]	Grit size					Opt. RPM		Description
			36	40	50	60	80			
EAN 4007220										

Cylindrical shape

13	-	25	-	-	804827	804872	804889	949757	30,000–44,000	100	GSB 1325 Z ...
19	-	25	-	804896	804902	804940	804957	949764	20,000–30,000	100	GSB 1925 Z ...
25	-	25	949771	805022	805077	805084	805091	949788	16,000–22,900	100	GSB 2525 Z ...
30	-	30	949795	805145	805152	805176	805183	-	13,000–19,100	100	GSB 3030 Z ...
38	-	25	949801	805190	949818	805206	949825	949832	10,000–15,900	100	GSB 3825 Z ...
45	-	30	-	805664	805671	805725	805732	-	8,500–12,700	100	GSB 4530 Z ...
51	-	25	949849	803943	949856	803950	803967	949863	7,500–11,200	100	GSB 5125 Z ...

Conical shape

20	14	63	950050	-	950074	950081	950098	950104	19,000–26,000	100	GSB 201463 Z ...
29	22	30	950067	-	950128	950135	950142	950159	13,000–19,100	100	GSB 292230 Z ...
36	22	60	950166	-	950241	950258	950265	950289	10,000–15,900	100	GSB 362260 Z ...

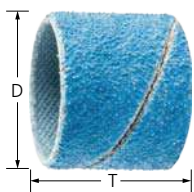

Zirconia alumina Z-COOL type

For coarse grinding work with a high stock removal rate and cool grinding.

Active grinding additives in the coating substantially improve the stock removal rate, prevent clogging and result in cooler grinding.

Abrasive:
Zirconia alumina Z-COOL

Ordering notes:

- Grit size 150 is supplied with aluminium oxide A-COOL (brown).
- Please complete the description with the desired grit size.

D [mm]	T [mm]	Grit size				Opt. RPM		Description
		36	50	80	150			
EAN 4007220								

Cylindrical shape

15	30	-	147887	147894	147924	26,000–36,000	100	GSB 1530 Z-COOL ...
22	20	-	148020	148037	148068	18,000–26,000	100	GSB 2220 Z-COOL ...
30	30	148228	148235	148242	148273	13,000–19,100	100	GSB 3030 Z-COOL ...
45	30	148426	148433	148440	148471	8,500–12,700	100	GSB 4530 Z-COOL ...
60	30	148587	148594	148600	148631	6,500–9,500	100	GSB 6030 Z-COOL ...



Ceramic oxide grain CO-COOL type

For aggressive grinding with maximum stock removal rate on hard and tough materials which do not conduct heat well. Consistently high performance due to self-sharpening ceramic oxide grain.

Active grinding additives in the coating substantially improve the stock removal rate, prevent clogging and result in cooler grinding.

The packaging size is ideally suited to industrial requirements.

Abrasive:

Ceramic oxide grain CO-COOL

Ordering notes:

■ Please complete the description with the desired grit size.

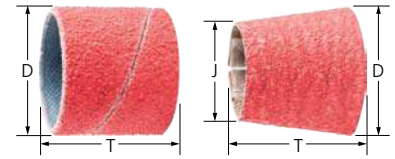

D [mm]	J [mm]	T [mm]	Grit size				Opt. RPM		Description
			36	60	80	120			
EAN 4007220									

Cylindrical shape

13	-	25	-	088074	092415	088227	30,000–44,000	100	GSB 1325 CO-COOL ...
15	-	30	-	772195	772201	772218	26,000–36,000	100	GSB 1530 CO-COOL ...
19	-	25	088234	088333	088340	088432	20,000–30,000	100	GSB 1925 CO-COOL ...
22	-	20	-	772225	772232	772249	18,000–26,000	100	GSB 2220 CO-COOL ...
25	-	25	088456	772256	772263	772270	16,000–22,900	100	GSB 2525 CO-COOL ...
30	-	30	772287	772294	772317	772331	13,000–19,100	100	GSB 3030 CO-COOL ...
38	-	25	088494	088500	088579	088586	10,000–15,900	100	GSB 3825 CO-COOL ...
45	-	30	772355	772362	772393	772409	8,500–12,700	100	GSB 4530 CO-COOL ...
51	-	25	088661	088678	088753	088760	7,500–11,200	100	GSB 5125 CO-COOL ...
60	-	30	772416	772423	772430	772447	6,500–9,500	100	GSB 6030 CO-COOL ...

Conical shape

20	14	63	950302	950319	950326	950340	19,000–26,000	100	GSB 201463 CO-COOL ...
29	22	30	950364	950388	950395	950418	13,000–19,100	100	GSB 292230 CO-COOL ...
36	22	60	950432	950456	950463	950487	10,000–15,900	100	GSB 362260 CO-COOL ...

Silicon carbide SiC type

For universal grinding on components made from aluminium, copper, bronze, titanium and fibre-reinforced plastics.

Particularly recommended for use on titanium alloys.

Ideally suited to use in the aeronautical industry, especially where SiC is the only approved abrasive, e.g. for use on engine components.

Abrasive:

Silicon carbide SiC

Ordering notes:

■ Please complete the description with the desired grit size.

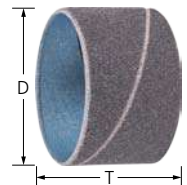

D [mm]	T [mm]	Grit size				Opt. RPM		Description
		60	80	100	150			
EAN 4007220								

Cylindrical shape

10	20	066270	066294	066300	066317	30,000–44,000	100	GSB 1020 SiC ...
13	25	066324	066348	066355	066362	30,000–44,000	100	GSB 1325 SiC ...
15	30	066379	066386	066393	066409	26,000–36,000	100	GSB 1530 SiC ...
22	20	066416	066423	066430	066447	18,000–26,000	100	GSB 2220 SiC ...
30	30	066454	066461	066478	066485	13,000–19,100	100	GSB 3030 SiC ...
45	30	066492	066508	066515	066522	8,500–12,700	100	GSB 4530 SiC ...



Abrasive spiral bands

Rubber drum holders GK

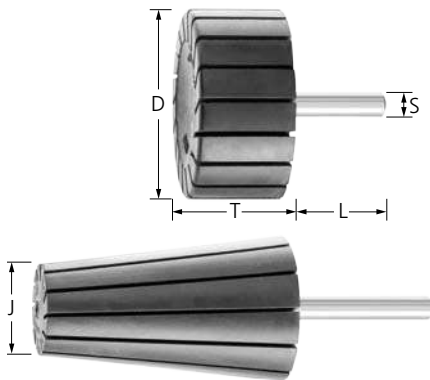

Conical and cylindrical types

Matching rubber drum holder for conical and cylindrical abrasive spiral bands.

Rubber drum holders marked "H" are the harder type and permit grinding at higher contact pressure. They are extremely well-suited to work on weld seams.

D [mm]	J [mm]	T [mm]	S [mm]	L [mm]	Hardness [Shore A]	EAN 4007220	Acc. to ISO standards	Max. RPM	Minimum rotational speed [RPM]		Description
--------	--------	--------	--------	--------	--------------------	-------------	-----------------------	----------	--------------------------------	---	-------------

Cylindrical shape

4	-	10	3	40	65-70	146729	-	55,000	30,000	5	GK 0410/3
			6	40	65-70	146712	-	55,000	30,000	5	GK 0410/6
6	-	10	3	40	65-70	146743	-	55,000	30,000	5	GK 0610/3
			6	40	65-70	146736	-	55,000	30,000	5	GK 0610/6
8	-	10	3	40	65-70	146767	-	55,000	30,000	5	GK 0810/3
			6	40	65-70	146750	-	55,000	30,000	5	GK 0810/6
10	-	10	6	35	65-70	146774	15637-1	44,000	30,000	5	GK 1010/6
		20	6	35	65-70	146781	15637-1	44,000	30,000	5	GK 1020/6
13	-	10	6	35	65-70	146798	-	44,000	30,000	5	GK 1310/6
		25	6	35	65-70	146804	-	44,000	30,000	5	GK 1325/6
15	-	10	6	35	65-70	146811	15637-1	36,000	26,000	5	GK 1510/6
		30	6	35	65-70	146828	15637-1	36,000	26,000	5	GK 1530/6
19	-	25	6	35	65-70	146835	-	30,000	20,000	5	GK 1925/6
22	-	20	6	35	65-70	146842	15637-1	26,000	18,000	5	GK 2220/6
					80	146859	15637-1	26,000	18,000	5	GK 2220/6 H
25	-	25	6	35	65-70	146866	-	22,900	16,000	5	GK 2525/6
30	-	20	6	35	65-70	146873	15637-1	19,100	13,000	5	GK 3020/6
			6	35	65-70	146880	15637-1	19,100	13,000	5	GK 3030/6
			6	35	80	146897	15637-1	19,100	13,000	5	GK 3030/6 H
38	-	25	6	35	65-70	146903	-	15,900	10,000	5	GK 3825/6
45	-	30	6	35	65-70	146927	15637-1	12,700	8,500	5	GK 4530/6
					80	146934	15637-1	12,700	8,500	5	GK 4530/6 H
51	-	25	6	35	65-70	146941	-	11,200	7,500	5	GK 5125/6
60	-	30	6	35	65-70	146958	15637-1	9,500	6,500	5	GK 6030/6
			8	35	65-70	146965	15637-1	9,500	6,500	5	GK 6030/8
75	-	30	8	35	65-70	146972	15637-1	7,600	5,000	5	GK 7530/8
100	-	40	8	35	65-70	146989	15637-1	5,700	4,000	5	GK 10040/8

Conical shape

20	14	63	6	40	65-70	147078	-	26,000	19,000	5	GK 201463/6
29	22	30	6	40	65-70	147085	-	19,100	13,000	5	GK 292230/6
36	22	60	6	40	65-70	147092	-	15,900	10,000	5	GK 362260/6



POLIROLL and POLICO tools are suited for work in hard-to-access places.

They consist of spirally wound, coated abrasives. The abrasive grain is embedded in the resinoid coating on the sturdy backing material, which achieves the best possible abrasive performance.

Advantages:

- Constantly high abrasive performance throughout the entire tool life thanks to fresh abrasive grain being constantly freed up in operation.
- Secure fit of the POLIROLL/POLICO when in use due to self-tensioning provided by grooved, conical arbor.
- Easy tool changing.

Applications:

- Levelling
- Deburring
- Work on edges
- Sharpening
- Work on weld seams
- Step-by-step fine grinding

Recommendations for use:

- Grind with the tip instead of the flat surface so as not to damage the bond through exposure to heat.
- Mount POLIROLL with the bonded side facing towards the arbor.
- Use grinding oil which is suitable for the material in order to considerably increase the tool life and abrasive performance of the tools. More detailed information and ordering data for grinding oils can be found on page 155.

Recommended rotational speed range

Example:

PR 1225 A 80

Cutting speed: 8 m/s

Rotational speed: 12,700 RPM

Matching tool drives:

- Flexible shaft drives
- Straight grinders

Ordering notes:

- When ordering, please state the EAN or the full description.
- **Ordering example:**
EAN 4007220**803394**
PR 1225 A **80**
- **Ordering example explanation:**
PR = POLIROLL cylindrical cartridge rolls
1225 = Outer diameter D x width T [mm]
A = Abrasive
80 = Grit size

Safety notes:

- The maximum permitted peripheral speed is 11 m/s.
- For safety reasons, the specified maximum permitted rotational speed must never be exceeded.



Accessories:

- Arbor for POLIROLL and POLICO



Tool dia. [mm]	Cutting speed [m/s]		
	5	8	11
	Rotational speeds [RPM]		
6	15,900	25,400	35,000
9	10,600	16,900	23,300
12	7,900	12,700	17,500
14	6,800	10,900	15,000
18	5,300	8,400	11,600

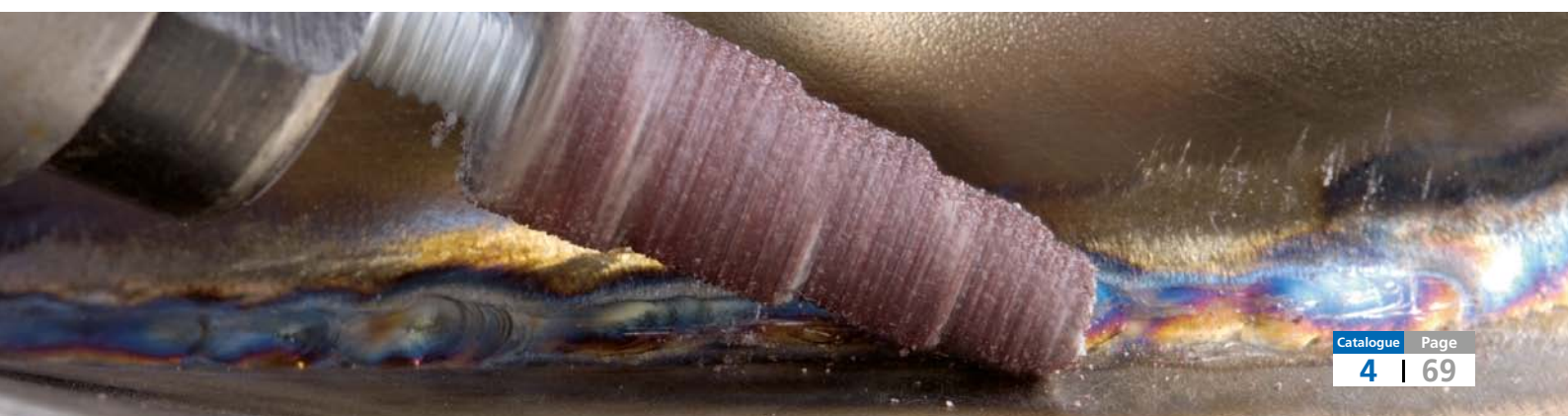

POLIROLL, POLICO

POLIROLL cartridge rolls PR and PRK, POLICO abrasive cones PCO

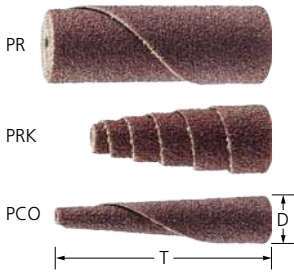

Aluminium oxide A type

For universal grinding work on metals and other materials.

Materials that can be worked:

aluminium, copper, brass, grey/nodular cast iron (GG/GJL, GGG/GJS), annealed cast iron, steel, cast steel, hardened, heat-treated steels over 1,200 N/mm² (> 38 HRC)

Abrasive:

Aluminium oxide A

Ordering notes:

■ Please complete the description with the desired grit size.

D [mm]	T [mm]	Grit size			Opt. RPM	Max. RPM	Suitable arbors		Description
		50	80	150					
EAN 4007220									

Cylindrical shape (PR)

6	25	-	152300	152317	20,000	25,000	BO 3-18-3, BO 6-18-3	50	PR 0625 A ...
	35	-	152324	152331					BO 6-24-3
9	25	-	152348	152355	15,000	23,000	BO 6-18-3	50	PR 0925 A ...
	35	-	152362	152379					BO 6-24-3
12	25	152386	152393	152409	12,000	17,000	BO 6-18-3	50	PR 1225 A ...
	35	152416	152423	152430					BO 6-24-3
18	35	152447	152454	152461	8,000	12,000	BO 6-25-5	50	PR 1835 A ...
	50	152478	152485	152492					BO 6-30-5

Conical shape (PRK)

10	25	-	152508	152515	15,000	23,000	BO 3-18-3, BO 6-18-3	50	PRK 1025 A ...
12	25	152522	152539	152546	12,000	17,000	BO 6-18-3	50	PRK 1225 A ...
	35	152553	152560	152577					BO 6-24-3
15	35	152584	152591	152607	10,000	15,000	BO 6-24-3	50	PRK 1535 A ...

POLICO abrasive cones (PCO)

10	50	-	152614	152621	15,000	23,000	BO 6-50-8	50	PCO 1050 A ...
----	----	---	--------	--------	--------	--------	-----------	----	----------------

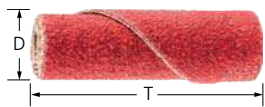

Ceramic oxide grain CO-COOL type

For aggressive grinding with maximum stock removal rate on hard materials which do not conduct heat well.

Consistently high performance due to self-sharpening ceramic oxide grain. Active grinding additives in the coating substantially improve the stock removal rate, prevent clogging and result in cooler grinding.

Materials that can be worked:

aluminium, cobalt-based alloys, nickel-based alloys (e.g. Inconel and Hastelloy), titanium, stainless steel (INOX)

Abrasive:

Ceramic oxide grain CO-COOL

Ordering notes:

■ Please complete the description with the desired grit size.

D [mm]	T [mm]	Grit size			Opt. RPM	Max. RPM	Suitable arbors		Description
		60	80	120					
EAN 4007220									
6	25	803264	803271	803288	20,000	25,000	BO 3-18-3, BO 6-18-3	50	PR 0625 CO-COOL ...
	35	803295	803301	803318					BO 6-24-3
9	25	803325	803332	803349	15,000	23,000	BO 6-18-3	50	PR 0925 CO-COOL ...
	35	803356	803363	803370					BO 6-24-3
12	25	803387	803394	803400	12,000	17,000	BO 6-18-3	50	PR 1225 CO-COOL ...
	35	803424	803431	803448					BO 6-24-3

Arbors BO

Arbors for POLIROLL and POLICO tools.

Advantages:

- Tool can be changed without unclamping the arbor from the tool drive collet.

Ordering notes:

- Arbor BO 6-50-8 – matching PCO 1050. The cone of the clamping piece is 5°.



Suitable for	S [mm]	L [mm]	EAN 4007220		Description
PR 0625, PRK 1025	3	27	152171	1	BO 3-18-3
PR 0625, PR 0925, PR 1225, PRK 1025, PRK 1225	6	30	152188	1	BO 6-18-3
PR 0635, PR 0935, PR 1235, PRK 1235, PRK 1535	6	30	152195	1	BO 6-24-3
PR 1835	6	30	152201	1	BO 6-25-5
PR 1850	6	30	152218	1	BO 6-30-5
PCO 1050	6	30	152232	1	BO 6-50-8

POLIROLL set

Set of different POLIROLL cartridge rolls with matching arbors.

Contents:

150 POLIROLL cartridge rolls with matching arbor:

- 20 pcs. each of PR 0625, A 80 and A 150
- 20 pcs. each of PR 0925, A 80 and A 150
- 20 pcs. each of PR 1225, A 80 and A 150
- 10 pcs. each of PRK 1025, A 80 and A 150
- 10 pcs. each of PRK 1225, A 80

Advantages:

- Coordinated selection of the most common versions.



4



L x B x H [mm]	EAN 4007220		Description
180 x 145 x 40	335727	1	PRS 151

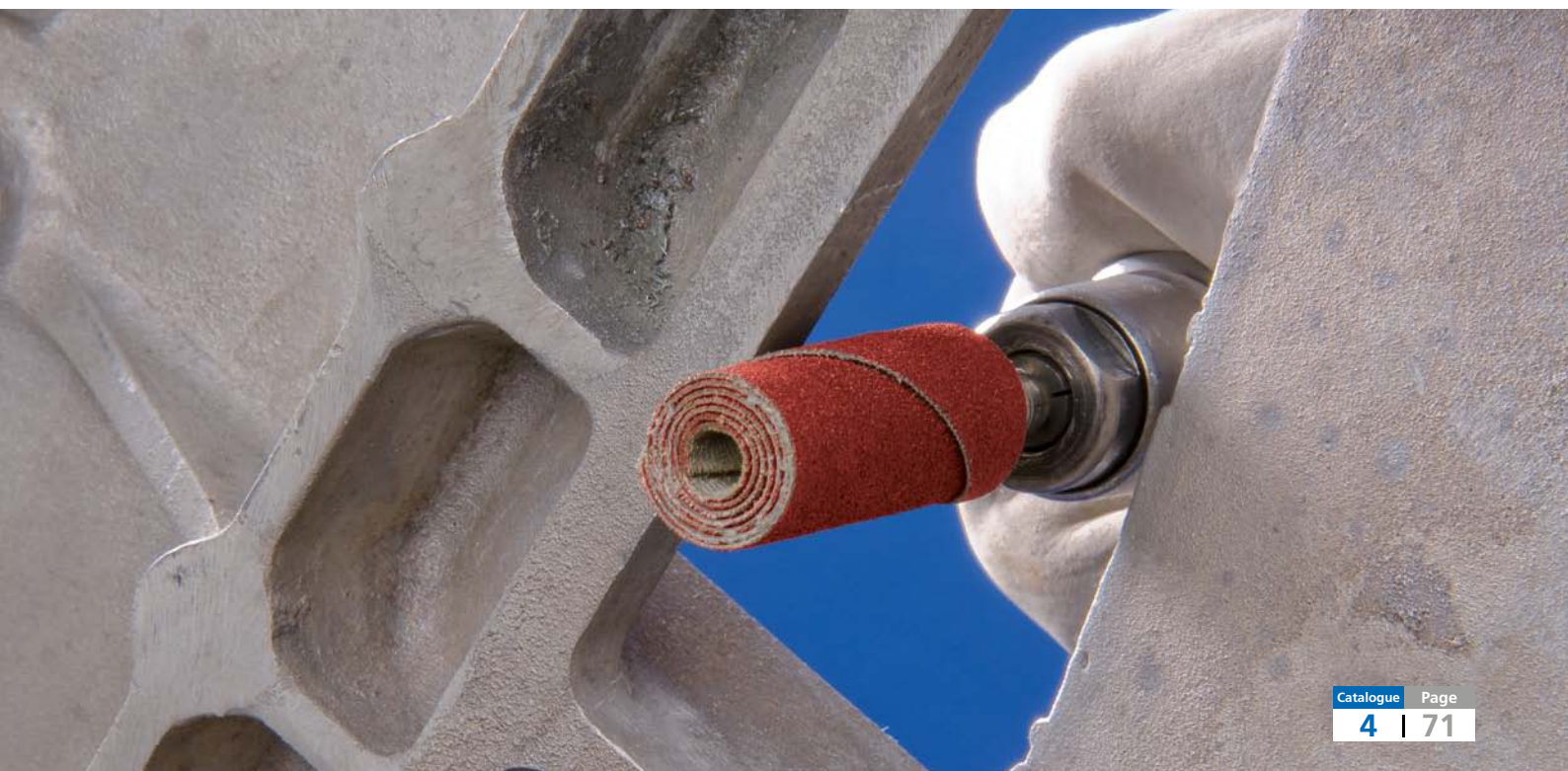

The broad, material-specific range of POLICAP abrasive cap and spiral band products offers tool solutions with the highest possible stock removal rate for universal and specific grinding applications alike.

POLICAP tools have a seamless design, and the entire tool surface can be used.

Perfectly matching, reusable holders are available for using abrasive caps and spiral bands.

Advantages:

- Abrasive caps and spiral bands fit securely on the holder as it expands during use.
- High standards of shape accuracy and excellent fine grinding thanks to a special manufacturing process.
- Easy tool changing.

Applications:

- Levelling
- Surface work
- Step-by-step fine grinding

Recommendations for use:

- To change the abrasive caps and spiral bands easily, raise and lower them while turning slightly to the right. When doing so, leave the tool carrier engaged in the tool drive and fix in place.
- For best performance, use with a recommended cutting speed of 10–20 m/s.

Matching tool drives:

- Flexible shaft drives
- Straight grinders

Ordering notes:

- When ordering, please state the EAN or the full description.
- **Ordering example:**
EAN 4007220**150849**
PC ZYA 1015 A **60**
- **Ordering example explanation:**
PC = POLICAP abrasive caps
ZYA = Cylindrical shape
1015 = Outer diameter D x width T [mm]
A = Abrasive
60 = Grit size

Safety notes:



- The maximum permitted peripheral speed is 25 m/s.
- For safety reasons, the specified maximum permitted rotational speed must never be exceeded.



Accessories:

- Abrasive cap and rubber drum holder



Type	Application
Aluminium oxide A  A60/80 A150 A280	For universal use on steel materials (hardened, heat-treated, non-hardened). Especially developed for specific applications, e.g. in tool- and mould-making, in addition to corresponding repair tasks. Also suitable for work on plastics, wood and fillers in model-making applications.
SiC-COOL (Silicon carbide with active grinding layer) 	Ideal for work on components made from titanium, aluminium and their respective alloys. Ideally suited to use in aircraft and turbine construction, in addition to associated maintenance tasks. The special grain selection and the active grinding additive in the bond facilitate cool grinding, reduce the workpiece temperature and prevent chips from adhering.
CO-COOL (Ceramic oxide grain with active grinding layer) 	The specific structure of the ceramic oxide grain and the active-grinding bond components make this ideal for work on stainless steels (INOX) and the high-temperature-resistant nickel-based and cobalt-based alloys that are frequently used in turbine construction, e.g. Inconel, Hastelloy. The active grinding additives prevent clogging and facilitate cooler grinding with considerably higher stock removal rate.

The fast way to the best tool

Material group ▼		Abrasive ▶	Aluminium oxide A	Ceramic oxide grain CO-COOL	Silicon carbide SiC-COOL
Steel, cast steel	Non-hardened, non-heat-treated steels	Construction steels, carbon steels, tool steels, non-alloyed steels, cast steel	●	○	
	Hardened, heat-treated steels	Tool steels, tempering steels, alloyed steels, cast steel	○	●	
Stainless steel (INOX)	Rust- and acid-resistant steels	Austenitic and ferritic stainless steels		●	
Non-ferrous metals	Soft non-ferrous metals, non-ferrous metals	Soft aluminium alloys	○	○	●
		Brass, copper, zinc	●		
	Hard non-ferrous metals	Hard aluminium alloys	○		●
		Bronze, titanium		○	●
High-temperature- resistant materials	Nickel-based and cobalt-based alloys		●		
Cast iron	Grey cast iron, white cast iron	Cast iron with flake graphite EN-GJL (GG), with nodular graphite/nodular cast iron EN-GJS (GGG), white an- nealed cast iron EN-GJMW (GTW), black cast iron EN-GJMB (GTS)	●	○	
Plastics, other materials		Fibre-reinforced plastics, thermoplastics, wood, chipboard, paintwork	○		●

● = Highly suitable

○ = Suitable

4



Recommended rotational speed range

Example:

PC ZYA 1015 A 150

Cutting speed: 10–20 m/s

Rotational speed: 19,000–38,100 RPM

Tool dia. [mm]	Cutting speed [m/s]			
	10	15	20	25
	Rotational speeds [RPM]			
5	38,100	57,200	76,300	95,400
7	27,200	40,900	54,500	68,200
10	19,000	28,600	38,100	47,700
11	17,300	26,000	34,700	43,400
16	11,900	17,900	23,800	29,800
21	9,000	13,600	18,100	22,700
29	6,500	9,800	13,100	16,400
36	5,300	7,900	10,600	13,200

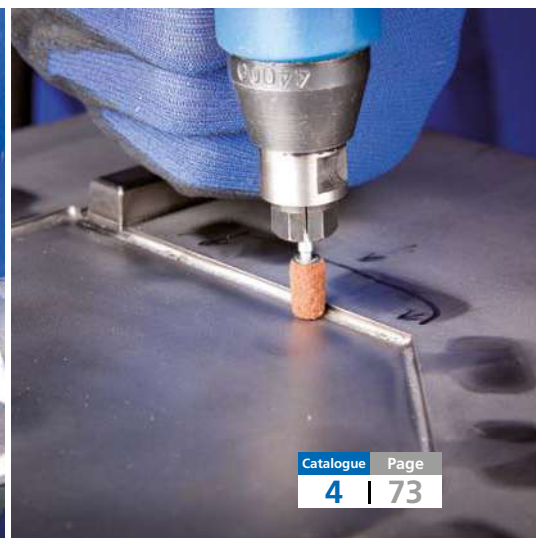



Abrasive caps PC ZYA

POLICAP abrasive caps in cylindrical shape ZYA (previously shape A).

Abrasive:

Aluminium oxide A
Grit size colour code:
60 and 80= brown
150 = black
280 = red-brown

Ordering notes:

■ Please complete the description with the desired grit size.

D [mm]	T [mm]	Grit size				Opt. RPM		Description
		60	80	150	280			
EAN 4007220								
5	10	-	150788	150795	150801	40,000	50	PC ZYA 0510 A ...
7	12	150818	-	150825	150832	30,000	50	PC ZYA 0712 A ...
10	15	150849	-	150856	150863	20,000	50	PC ZYA 1015 A ...
13	17	150870	-	150887	150894	16,000	50	PC ZYA 1317 A ...
16	26	150900	-	150917	150924	12,000	50	PC ZYA 1626 A ...

PCT, shape ZYA

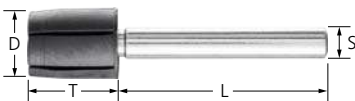

Abrasive cap holders PCT ZYA

Matching POLICAP abrasive cap holder in cylindrical shape ZYA (previously shape A).

D [mm]	T [mm]	S [mm]	L [mm]	EAN 4007220	Max. RPM		Description
5	10	3	25	147139	95,000	5	PCT ZYA 0510/3
7	12	3	25	147146	65,000	5	PCT ZYA 0712/3
10	15	3	25	147153	45,000	5	PCT ZYA 1015/3
13	17	6	40	147221	35,000	5	PCT ZYA 1317/6
16	26	6	40	147238	30,000	5	PCT ZYA 1626/6

PCS, shape ZYA



Set PCS ZYA

Set of various POLICAP abrasive caps with matching holder in cylindrical shape ZYA (previously shape A).

Contents:

- 5 pcs. each of POLICAP abrasive caps PC ZYA 1015 A, 1317 A and 1626 A (grit size 60, 150, 280)
- 10 pcs. each of POLICAP abrasive caps PC ZYA 0510 A and 0712 A (grit size 60 or 80 and 150, 280)
- 1 pc. each of POLICAP abrasive cap holder PCT ZYA 0510/3, 0712/3, 1015/3, 1317/6 and 1626/6

Advantages:

- Sturdy, reusable plastic packaging.

Abrasive:

Aluminium oxide A
60 and 80= brown
150 = black
280 = red-brown

Shape	L x B x H [mm]	EAN 4007220		Description
ZYA	180 x 145 x 40	355404	1	PCS ZYA 110

Abrasive caps PC WRC

POLICAP abrasive caps in cylindrical shape with radius end WRC (previously shape C).

Abrasive:

Aluminium oxide A
 Silicon carbide SiC-COOL (grey)
 Ceramic oxide grain CO-COOL (red)
 Grit size colour code for aluminium oxide A:
 60 and 80= brown
 150 = black
 280 = red-brown

Ordering notes:

■ Please complete the description with the desired grit size.

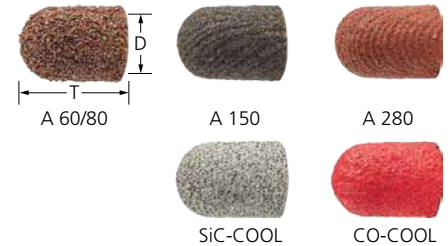

D [mm]	T [mm]	Grit size					Opt. RPM		Description
		60	80	120	150	280			
EAN 4007220									

Aluminium oxide A

5	11	-	150931	-	150948	150955	40,000	50	PC WRC 0511 A ...
7	13	150962	-	-	150979	150986	30,000	50	PC WRC 0713 A ...
10	15	150993	-	-	151006	151013	20,000	50	PC WRC 1015 A ...
13	17	151020	-	-	151037	151044	16,000	50	PC WRC 1317 A ...
16	26	151051	-	-	151068	151075	12,000	50	PC WRC 1626 A ...

Silicon carbide SiC-COOL

5	11	-	953716	-	953723	-	40,000	50	PC WRC 0511 SiC-COOL ...
7	13	-	953730	-	953747	-	30,000	50	PC WRC 0713 SiC-COOL ...
10	15	-	953754	-	953761	-	20,000	50	PC WRC 1015 SiC-COOL ...
13	17	-	953778	-	953792	-	16,000	50	PC WRC 1317 SiC-COOL ...
16	26	-	953808	-	953815	-	12,000	50	PC WRC 1626 SiC-COOL ...

Ceramic oxide grain CO-COOL

5	11	-	953938	953945	-	-	40,000	50	PC WRC 0511 CO-COOL ...
7	13	-	953952	953969	-	-	30,000	50	PC WRC 0713 CO-COOL ...
10	15	-	953976	954041	-	-	20,000	50	PC WRC 1015 CO-COOL ...
13	17	-	954058	954119	-	-	16,000	50	PC WRC 1317 CO-COOL ...
16	26	-	954126	954133	-	-	12,000	50	PC WRC 1626 CO-COOL ...

PCT, shape WRC

Abrasive cap holders PCT WRC

Matching POLICAP abrasive cap holder in cylindrical shape with radius end WRC (previously shape C).

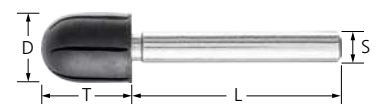

D [mm]	T [mm]	S [mm]	L [mm]	EAN 4007220	Max. RPM		Description
5	11	2.35	40	621820	30,000	5	PCT WRC 0511/2,35
		3	25	147160	95,000	5	PCT WRC 0511/3
7	13	2.35	40	621837	24,500	5	PCT WRC 0713/2,35
		3	25	147177	65,000	5	PCT WRC 0713/3
10	15	2.35	40	621844	17,500	5	PCT WRC 1015/2,35
		3	25	147184	45,000	5	PCT WRC 1015/3
13	17	2.35	40	621851	13,750	5	PCT WRC 1317/2,35
		6	40	147245	35,000	5	PCT WRC 1317/6
16	26	6	40	147252	30,000	5	PCT WRC 1626/6



Set PCS WRC

Set of various POLICAP abrasive caps with matching holder in cylindrical shape with radius end WRC (previously shape C).

Contents:

- 5 pcs. each of POLICAP abrasive caps PC WRC 1015 A, 1317 A and 1626 A (grit size 60, 150, 280)
- 10 pcs. each of POLICAP abrasive caps PC WRC 0511 A and 0713 A (grit size 60 or 80 and 150, 280)
- 1 pc. each of POLICAP abrasive cap holder PCT WRC 0511/3, 0713/3, 1015/3, 1317/6 and 1626/6

Advantages:

- Sturdy, reusable plastic packaging.

Abrasive:

Aluminium oxide A
Grit size colour code:
60 and 80= brown
150 = black
280 = red-brown

Shape	L x B x H [mm]	EAN 4007220		Description
WRC	180 x 145 x 40	355411	1	PCS WRC 110



Abrasive caps PC WKG

POLICAP abrasive caps in tapered conical shape with radius end WKG (previously shape G). The taper angle of the cone is 30°.



Abrasive:

Aluminium oxide A
Grit size colour code:
60 and 80= brown
150 = black
280 = red-brown

Ordering notes:

■ Please complete the description with the desired grit size.

D [mm]	T [mm]	Grit size				Opt. RPM		Description
		60	80	150	280			
EAN 4007220								
5	11	-	151082	151099	151105	40,000	50	PC WKG 0511 A ...
7	13	151112	-	151129	151136	30,000	50	PC WKG 0713 A ...
10	15	151143	-	151150	151167	20,000	50	PC WKG 1015 A ...
13	17	151174	-	151181	151198	16,000	50	PC WKG 1317 A ...
16	26	151204	-	151211	151228	12,000	50	PC WKG 1626 A ...

PCT, shape WKG

Abrasive cap holders PCT WKG

Matching POLICAP abrasive cap holder in tapered conical shape with radius end WKG (previously shape G).

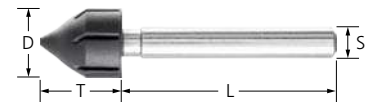

D [mm]	T [mm]	S [mm]	L [mm]	EAN 4007220	Max. RPM		Description
5	11	3	25	147191	95,000	5	PCT WKG 0511/3
7	13	3	25	147207	65,000	5	PCT WKG 0713/3
10	15	3	25	147214	45,000	5	PCT WKG 1015/3
13	17	2.35	40	434338	13,750	5	PCT WKG 1317/2,35
		6	40	147269	35,000	5	PCT WKG 1317/6
16	26	6	40	147276	30,000	5	PCT WKG 1626/6

PCS, shape WKG

Set PCS WKG

Set of various POLICAP abrasive caps with matching holder in tapered conical shape with radius end WKG (previously shape G).

Contents:

- 5 pcs. each of POLICAP abrasive caps PC WKG 1015 A, 1317 A and 1626 A (grit size 60, 150, 280)
- 10 pcs. each of POLICAP abrasive caps PC WKG 0511 A and 0713 A (grit size 60 or 80 and 150, 280)
- 1 pc. each of POLICAP abrasive cap holder PCT WKG 0511/3, 0713/3, 1015/3, 1317/6 and 1626/6

Advantages:

- Sturdy, reusable plastic packaging.

Abrasive:

Aluminium oxide A
60 and 80= brown
150 = black
280 = red-brown



Shape	L x B x H [mm]	EAN 4007220		Description
WKG	180 x 145 x 40	355428	1	PCS WKG 110

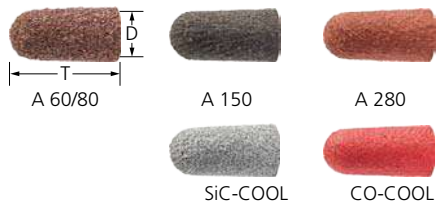

Abrasive caps PC KEL

POLICAP abrasive caps in conical shape with radius end KEL (previously shape L).

Abrasive:

Aluminium oxide A
Silicon carbide SiC-COOL (grey)
Ceramic oxide grain CO-COOL (red)
Grit size colour code for aluminium oxide A:
60 and 80= brown
150 = black
280 = red-brown

Ordering notes:

■ Please complete the description with the desired grit size.

D [mm]	T [mm]	Grit size					Opt. RPM		Description
		60	80	120	150	280			
EAN 4007220									

Aluminium oxide A

5	15	-	151235	-	151242	151259	40,000	50	PC KEL 0515 A ...
11	25	151266	-	-	151273	151280	20,000	50	PC KEL 1125 A ...
16	32	151297	-	-	151303	151310	12,000	50	PC KEL 1632 A ...
21	40	151327	-	-	151334	151341	9,500	50	PC KEL 2140 A ...

Silicon carbide SiC-COOL

5	15	-	953822	-	953839	-	40,000	50	PC KEL 0515 SiC-COOL ...
11	25	-	953846	-	953853	-	20,000	50	PC KEL 1125 SiC-COOL ...
16	32	-	953891	-	953907	-	12,000	50	PC KEL 1632 SiC-COOL ...
21	40	-	953914	-	953921	-	9,500	50	PC KEL 2140 SiC-COOL ...

Ceramic oxide grain CO-COOL

5	15	-	954140	954263	-	-	40,000	50	PC KEL 0515 CO-COOL ...
11	25	-	954164	954188	-	-	20,000	50	PC KEL 1125 CO-COOL ...
16	32	-	954195	954218	-	-	12,000	50	PC KEL 1632 CO-COOL ...
21	40	-	954225	954232	-	-	9,500	50	PC KEL 2140 CO-COOL ...

PCT, shape KEL

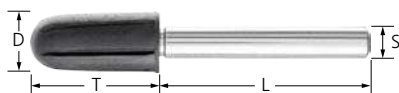

Abrasive cap holders PCT KEL

Matching POLICAP abrasive cap holder in conical shape with radius end KEL (previously shape L).

D [mm]	T [mm]	S [mm]	L [mm]	EAN 4007220	Max. RPM		Description
5	15	6	40	147283	95,000	5	PCT KEL 0515/6
11	25	6	40	147290	40,000	5	PCT KEL 1125/6
16	32	6	40	147306	30,000	5	PCT KEL 1632/6
21	40	6	40	147313	20,000	5	PCT KEL 2140/6

Set PCS 650

Set of various POLICAP abrasive caps with matching holder.

Contents:

- 10 pcs. each of POLICAP abrasive caps PC ZYA 1626 A and PC WKG 1626 A (grit size 150 and 280)
- 25 pcs. each of POLICAP abrasive caps PC ZYA 1015 A, PC ZYA 1317 A, PC WKG 1015 A and PC WKG 1317 A (grit size 150 and 280)
- 50 pcs. each of POLICAP abrasive caps PC ZYA 0510 A, PC ZYA 0712 A, PC WKG 0511 A and PC WKG 0713 A (grit size 150 and 280)
- 1 pc. each of POLICAP abrasive cap holder PCT ZYA 0510/3, PCT ZYA 0712/3, PCT ZYA 1015/3, PCT ZYA 1317/6, PCT ZYA 1626/6, PCT WKG 0511/3, PCT WKG 0713/3, PCT WKG 1015/3, PCT WKG 1317/6 and PCT WKG 1626/6

Advantages:

- Sturdy, reusable plastic packaging.

Abrasive:

Aluminium oxide A
 Grit size colour code:
 150 = black
 280 = red-brown



Shape	L x B x H [mm]	EAN 4007220		Description
ZYA, WKG	332 x 235 x 50	355435	1	SET PCS 650

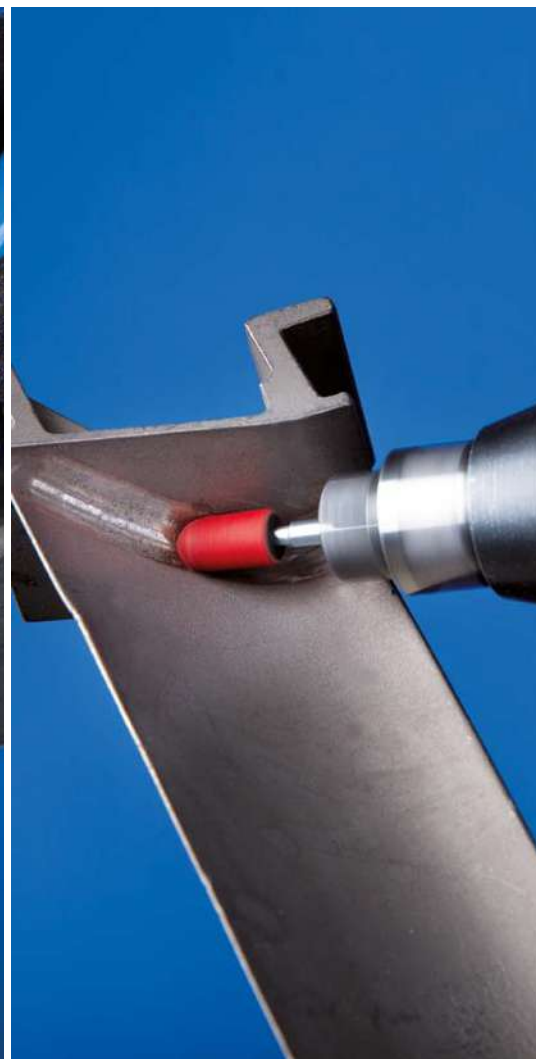

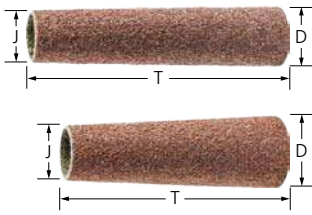

Abrasive cones PCH

POLICAP abrasive cones with a conical shape.

Abrasive:

Aluminium oxide A
 Grit size colour code:
 60 = brown
 150 = black
 280 = red-brown

Ordering notes:

■ Please complete the description with the desired grit size.

D [mm]	J [mm]	T [mm]	Grit size			Opt. RPM	Suitable arbors		Description
			60	150	280				
EAN 4007220									
7	5	85	151358	151365	151372	12,000	PCT 0585	10	PCH 070585 L A ...
14	11	85	151389	151396	-	12,000	PCT 1185	10	PCH 141185 L A ...
20	16	85	151419	151426	-	12,000	PCT 1685	10	PCH 201685 L A ...
24	21	85	151440	151457	-	12,000	PCT 2185	10	PCH 242185 L A ...
20	15	65	151471	151488	-	18,500	GK 201463	10	PCH 201565 L A ...
36	22	65	151532	-	-	13,000	GK 362260	10	PCH 362265 L A ...

PCT, shape KEL



Rubber abrasive cone holders PCT KEL

Matching POLICAP rubber abrasive cone holder in conical shape with radius end KEL (previously shape L).

Advantages:

■ The abrasive spiral bands are firmly held in place on the holder as the rubber surface offers excellent adhesion.

D [mm]	T [mm]	S [mm]	L [mm]	EAN 4007220	Max. RPM		Description
8	85	6	40	147320	20,000	5	PCT KEL 0585/6
13	85	6	40	147337	15,000	5	PCT KEL 1185/6
18	85	6	40	147344	13,000	5	PCT KEL 1685/6
23	85	6	30	147351	12,000	5	PCT KEL 2185/6

GK, conical shape

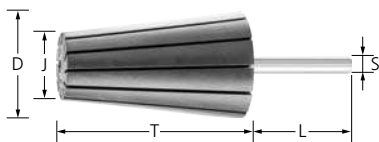

Rubber drum holders GK

Matching POLICAP rubber drum holder with a conical shape.

Advantages:

■ The abrasive spiral bands are firmly held in place on the holder as the holder expands during use.

D [mm]	J [mm]	T [mm]	S [mm]	L [mm]	EAN 4007220	Max. RPM	Minimum rotational speed [RPM]		Description
20	14	63	6	40	147078	26,000	19,000	5	GK 201463/6
36	22	60	6	40	147092	15,900	10,000	5	GK 362260/6

On mounted flap wheels, the flaps made of coated abrasive are arranged radially around the tool axis in a fan-type structure. Their flexibility enables them to adapt perfectly to the contours of the workpiece. The abrasive grain is embedded in the sturdy, flexible cloth backing material by means of a resinoid bond.

In ISO 3919, mounted flap wheels are designated as "flap wheels with shaft".

Factors that influence working results:

■ Tool wear and thermal load:

Tool wear and the thermal load of the workpiece are reduced by decreasing the contact pressure and peripheral speed, and adding grinding oil.

■ Stock removal:

Stock removal rate should be increased by using a coarser granulation and not by increasing the contact pressure. This avoids unnecessary tool wear and prevents the thermal load of the workpiece.

■ Surface roughness:

Increasing the cutting speed achieves a slightly finer surface. Increasing the contact pressure makes the surface slightly more coarse. The softer the material to be finished, the coarser the surface (when using the same grit sizes).

Advantages:

- Optimum adaptation to contours thanks to high flexibility.
- Consistently high stock removal throughout the entire tool life as new, aggressive abrasive material is constantly freed up.
- Face-down use very close to edges and in corners is possible thanks to the flat, moulded-core design.

Applications:

- Levelling
- Deburring
- Surface work
- Work on weld seams
- Structuring surfaces
- Step-by-step fine grinding

Recommendations for use:

- For best performance, use with a recommended cutting speed of 15–20 m/s. This provides an ideal compromise between stock removal rate, surface quality, thermal load on the workpiece and tool wear.
- Use grinding oil which is suitable for the material in order to considerably increase the tool life and abrasive performance of the tools. More detailed information and ordering data for grinding oils can be found on page 155.

Matching tool drives:

- Flexible shaft drives
- Straight grinders

Ordering notes:

- When ordering, please state the EAN or the full description.

■ Ordering example:

EAN 4007220155455

F 6030/6 A 120

■ Ordering example explanation:

- F = Mounted flap wheel
- 6030 = Outer diameter D x width T [mm]
- 6 = Shank diameter S_d [mm]
- A = Abrasive
- 120 = Grit size

Safety notes:

- For safety reasons, the specified maximum permitted rotational speed must never be exceeded.
- The contact pressure has to be reduced significantly when the optimum rotational speed is exceeded.
- Safety is only guaranteed when:
 - The clamping length is at least 15 mm.
 - The specified maximum rotational speed is not exceeded with unsupported shank lengths.



PFERDVALUE:

PFERDERGONOMICS recommends mounted flap wheels to sustainably reduce vibration and noise levels during use and to improve working comfort.

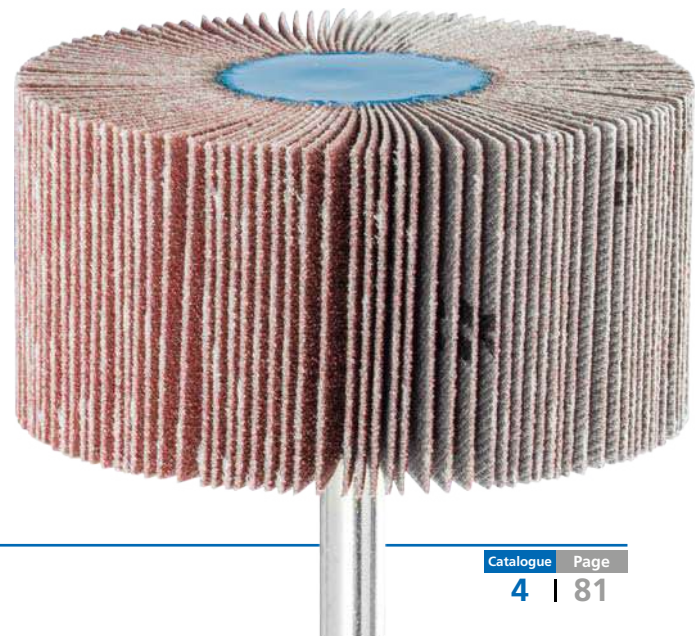

Flap tools

General information – Mounted flap wheels

The fast way to the best tool

Material group ▼		Abrasive ►	Aluminium oxide A	Zirconia alumina Z-COOL	Ceramic oxide grain CO-COOL	Silicon carbide SiC-COOL
Steel, cast steel	Non-hardened, non-heat-treated steels	Construction steels, carbon steels, tool steels, non-alloyed steels, cast steel	●	○	○	
	Hardened, heat-treated steels	Tool steels, tempering steels, alloyed steels, cast steel	○	●	●	
Stainless steel (INOX)	Rust- and acid-resistant steels	Austenitic and ferritic stainless steels		●	●	
Non-ferrous metals	Soft non-ferrous metals, non-ferrous metals	Soft aluminium alloys	○			●
		Brass, copper, zinc	●	○	○	
	Hard non-ferrous metals	Hard aluminium alloys	○			●
		Bronze, titanium		○	○	●
	High-temperature-resistant materials	Nickel-based and cobalt-based alloys		○	●	
Cast iron	Grey cast iron, white cast iron	Cast iron with flake graphite EN-GJL (GG), with nodular graphite/nodular cast iron EN-GJS (GGG), white annealed cast iron EN-GJMW (GTW), black cast iron EN-GJMB (GTS)	●	○	●	
Plastics, other materials		Fibre-reinforced plastics, thermoplastics, wood, chipboard, paintwork	○			●

● = Highly suitable

○ = Suitable

Recommended rotational speed range

Example:

F 6030/6 A 120

Cutting speed: 15–20 m/s

Rotational speed: 4,700–6,300 RPM

Tool dia. [mm]	Cutting speed [m/s]		
	15	20	40
	Rotational speeds [RPM]		
10	28,600	38,100	76,300
15	19,000	25,400	50,900
20	14,300	19,000	38,100
25	11,400	15,200	30,500
30	9,500	12,700	25,400
40	7,100	9,500	19,000
50	5,700	7,600	15,200
60	4,700	6,300	12,700
80	3,500	4,700	9,500



Aluminium oxide A type

For universal applications from coarse to fine grinding.

Abrasive:
Aluminium oxide A

PFERDVALUE:



Ordering notes:

■ Please complete the description with the desired grit size.

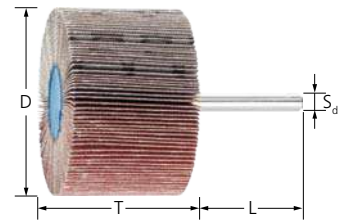

D [mm]	T [mm]	Grit size								Opt. RPM	Max. RPM		Description
		40	60	80	120	150	180	240	320				
EAN 4007220													

Shank dia. 3 x 40 mm [S_d x L]

10	10	-	661529	661635	661642	661659	661673	-	661680	-	38,000	75,000	10	F 1010/3 A ...
	15	-	661697	661703	661710	661727	661734	-	661741	-	38,000	75,000	10	F 1015/3 A ...
15	5	-	661758	661765	661772	661796	661802	-	661819	-	25,000	50,000	10	F 1505/3 A ...
	10	-	661871	661918	661925	661932	661963	-	661987	-	25,000	50,000	10	F 1510/3 A ...
	15	-	661994	662014	662038	662045	662052	-	662069	-	25,000	50,000	10	F 1515/3 A ...
20	10	-	-	336892	154113	154120	292563	378663	378670	-	19,000	38,100	10	F 2010/3 A ...
30	5	-	154137	154151	154175	154199	292693	154212	154236	-	12,000	25,400	10	F 3005/3 A ...
	10	-	154250	154274	154298	154311	292716	154335	154359	-	12,000	25,400	10	F 3010/3 A ...

Shank dia. 6 x 40 mm [S_d x L]

20	10	-	235478	292594	292617	292624	292631	-	-	-	19,000	38,100	10	F 2010/6 A ...
25	10	-	-	536896	536902	-	536919	-	-	-	15,000	30,500	10	F 2510/6 A ...
	15	-	-	154557	154564	154571	292648	-	-	-	15,000	30,500	10	F 2515/6 A ...
	20	-	-	536926	536933	-	536940	-	-	-	15,000	30,500	10	F 2520/6 A ...
	25	-	557440	292655	292662	292679	292686	-	-	-	15,000	30,500	10	F 2525/6 A ...
30	3	-	-	950838	950845	950852	950869	950876	950883	-	12,000	25,400	10	F 3003/6 A ...
	5	-	154144	154168	154182	154205	292709	154229	154243	-	12,000	25,400	10	F 3005/6 A ...
	10	-	154267	154281	154304	154328	292723	154342	154366	533017	12,000	25,400	10	F 3010/6 A ...
	15	-	154687	154694	154700	154717	292730	154724	154731	-	12,000	25,400	10	F 3015/6 A ...
	20	035153	035160	-	-	035177	035184	035191	035207	-	12,000	25,400	10	F 3020/6 A ...
	30	-	292747	292754	292761	292778	292785	292792	292808	-	12,000	25,400	10	F 3030/6 A ...
40	10	-	154373	154380	154403	154410	292815	154427	-	-	9,600	19,100	10	F 4010/6 A ...
	15	-	154441	154458	154465	154489	292822	154496	154519	-	9,600	19,100	10	F 4015/6 A ...
	20	800607	154625	154632	154649	154656	292839	154663	-	-	9,600	19,100	10	F 4020/6 A ...
50	5	-	950968	951019	951026	951033	951040	951057	951064	-	7,000	15,200	10	F 5005/6 A ...
	10	-	155189	155196	155202	155219	292846	155226	155233	-	7,000	15,200	10	F 5010/6 A ...
	15	-	155240	155257	155264	155271	292853	155288	155295	-	7,000	15,200	10	F 5015/6 A ...
	20	-	155127	155134	155141	155158	292860	-	155172	-	7,000	15,200	10	F 5020/6 A ...
	30	800591	155066	155073	155080	155097	292877	155103	155110	-	7,000	15,200	10	F 5030/6 A ...
60	5	-	951071	951088	951095	951101	951118	951125	951132	-	6,300	12,700	10	F 6005/6 A ...
	15	-	155301	155318	155325	155332	-	155349	155356	-	6,300	12,700	10	F 6015/6 A ...
	20	-	155363	155370	155387	155394	-	155400	155417	-	6,300	12,700	10	F 6020/6 A ...
	30	155424	155431	155448	155455	155462	292907	155479	155486	533024	6,300	12,700	10	F 6030/6 A ...
	40	-	155493	155509	155516	155523	-	155530	-	-	6,300	12,700	10	F 6040/6 A ...
	50	155554	155561	155578	155585	155592	-	155608	155615	-	6,300	12,700	10	F 6050/6 A ...
80	5	-	549780	373743	463062	403396	958889	102114	102121	-	4,800	9,500	10	F 8005/6 A ...
	10	-	422120	262184	422137	065877	065907	065914	048412	-	4,800	9,500	10	F 8010/6 A ...
	15	-	155622	155639	155646	155653	-	-	-	-	4,800	9,500	10	F 8015/6 A ...
	20	-	155684	155691	155707	155714	-	-	-	-	4,800	9,500	10	F 8020/6 A ...
	30	155745	155752	155769	155776	155783	-	155790	155806	-	4,800	9,500	10	F 8030/6 A ...
	40	-	155813	155820	155837	155844	-	155851	-	-	4,800	9,500	10	F 8040/6 A ...
	50	155875	155882	155899	155905	155912	-	155929	155936	-	4,800	9,500	10	F 8050/6 A ...



Flap tools

Mounted flap wheels F

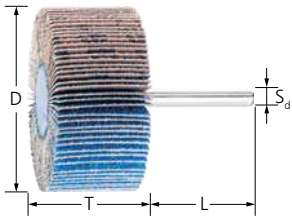

Zirconia alumina Z-COOL type

For coarse grinding work with a high stock removal rate and cool grinding.

Active grinding additives in the coating substantially improve the stock removal rate, prevent clogging and result in cooler grinding.

Abrasive:
Zirconia alumina Z-COOL

PFERDVALUE:



Ordering notes:

■ Please complete the description with the desired grit size.

D [mm]	T [mm]	Grit size		Opt. RPM	Max. RPM		Description
		60	80				
EAN 4007220							

Shank dia. 6 x 40 mm [S_d x L]

30	20	297353	297360	12,000	25,400	10	F 3020/6 Z-COOL ...
40	20	297377	297384	9,600	19,100	10	F 4020/6 Z-COOL ...
50	20	297391	297407	7,000	15,200	10	F 5020/6 Z-COOL ...
60	30	297414	297421	6,300	12,700	10	F 6030/6 Z-COOL ...
80	50	297438	297445	4,800	9,500	10	F 8050/6 Z-COOL ...

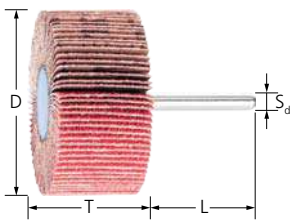

Ceramic oxide grain CO-COOL type

For aggressive grinding with maximum stock removal rate on hard materials which do not conduct heat well. Consistently high performance due to self-sharpening ceramic oxide grain.

Active grinding additives in the coating substantially improve the stock removal rate, prevent clogging and result in cooler grinding.

Abrasive:
Ceramic oxide grain CO-COOL

PFERDVALUE:



Ordering notes:

■ Please complete the description with the desired grit size.

D [mm]	T [mm]	Grit size				Opt. RPM	Max. RPM		Description
		40	60	80	120				
EAN 4007220									

Shank dia. 6 x 40 mm [S_d x L]

20	10	-	065938	884751	884775	19,000	38,100	10	F 2010/6 CO-COOL ...
30	10	803738	803745	803752	803769	12,000	25,400	10	F 3010/6 CO-COOL ...
	15	803776	803783	803790	803806	12,000	25,400	10	F 3015/6 CO-COOL ...
	20	035009	035016	035023	962046	12,000	25,400	10	F 3020/6 CO-COOL ...
40	20	803813	803820	803837	803844	9,600	19,100	10	F 4020/6 CO-COOL ...
50	30	803868	803875	803899	803882	7,000	15,200	10	F 5030/6 CO-COOL ...
60	15	065945	065952	000137	065969	6,300	12,700	10	F 6015/6 CO-COOL ...
	30	803905	803912	803929	803936	6,300	12,700	10	F 6030/6 CO-COOL ...



Silicon carbide SiC type

For universal grinding work on components made from aluminium, copper, bronze, titanium and fibre-reinforced plastics.

Particularly recommended for use on titanium alloys.

Ideally suited to use in the aeronautical industry, especially where SiC is the only approved abrasive, e.g. for use on engine components.

Abrasive:

Silicon carbide SiC

PFERDVALUE:



Ordering notes:

■ Please complete the description with the desired grit size.

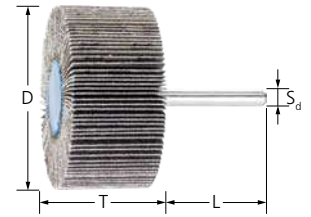

D [mm]	T [mm]	Grit size				Opt. RPM	Max. RPM	Image of box	Description
		60	80	120	150				
EAN 4007220									

Shank dia. 6 x 40 mm [S_d x L]

20	10	102145	102176	102183	102206	19,000	38,100	10	F 2010/6 SiC ...
30	10	154588	154595	154601	154618	12,000	25,400	10	F 3010/6 SiC ...
	15	102213	102220	102268	102275	12,000	25,400	10	F 3015/6 SiC ...
40	20	102299	102343	102367	102398	12,000	25,400	10	F 3020/6 SiC ...
	20	102411	102442	102459	102480	9,600	19,100	10	F 4020/6 SiC ...
50	30	102510	102572	102626	102633	7,000	15,200	10	F 5030/6 SiC ...
60	15	102657	102664	102701	102718	6,300	12,700	10	F 6015/6 SiC ...
	30	155943	155950	155967	155974	6,300	12,700	10	F 6030/6 SiC ...

Mounted flap wheel set

FSO

Set of different mounted flap wheels in the aluminium oxide A type with a shank diameter of 6 mm.

Contents:

5 pcs. each of mounted flap wheels:

- F 4015/6 A 80
- F 4015/6 A 120
- F 5015/6 A 60
- F 5015/6 A 80
- F 6030/6 A 60
- F 6040/6 A 80
- F 6040/6 A 150
- F 8030/6 A 60

Advantages:

- Getting to know and testing the comprehensive range.
- Coordinated selection of the most common versions.
- Promotional display box.

Abrasive:

Aluminium oxide A

PFERDVALUE:



L x B x H [mm]	EAN 4007220	Image of box	Description
240 x 145 x 240	156087	1	FSO 5400



Flap tools

Unmounted flap wheels

On unmounted flap wheels, the flaps made of coated abrasive are arranged radially around the tool axis in a fan-type structure. Their flexibility enables them to adapt perfectly to the contours of the workpiece. The abrasive grain is embedded in the sturdy, flexible cloth backing material by means of a resinoid bond.

In ISO 5429, unmounted flap wheels are designated as "flap wheels".

Factors that influence working results:

■ Tool wear and thermal load:

Tool wear and the thermal load of the workpiece are reduced by decreasing the contact pressure and peripheral speed, and adding grinding oil.

■ Stock removal:

Stock removal rate should be increased by using a coarser granulation and not by increasing the contact pressure. This avoids unnecessary tool wear and prevents the thermal load of the workpiece.

■ Surface roughness:

Increasing the cutting speed achieves a slightly finer surface. Increasing the contact pressure makes the surface slightly more coarse. The softer the material to be finished, the coarser the surface (when using the same grit sizes).

Advantages:

- Optimum adaptation to contours thanks to high flexibility.
- Consistently high stock removal throughout the entire tool life as new, aggressive abrasive material is constantly freed up.
- Face-down use very close to edges and in corners is possible thanks to the special clamping system.

Applications:

- Levelling
- Deburring
- Surface work
- Work on weld seams
- Structuring surfaces
- Step-by-step fine grinding

Recommendations for use:

- For best performance, use with a recommended cutting speed of 15–30 m/s. This provides an ideal compromise between stock removal rate, surface quality, thermal load on the workpiece and tool wear.
- Use grinding oil which is suitable for the material in order to considerably increase the tool life and abrasive performance of the tools. More detailed information and ordering data for grinding oils can be found on page 155.
- For best performance, use a tool drive with 1,000–1,500 watts.

Ordering notes:

- When ordering, please state the EAN or the full description.
- **Ordering example:**
EAN 4007220**469040**
FR 10030/25,4 A **40**
- **Ordering example explanation:**
FR = Unmounted flap wheels
10030 = Outer diameter D x width T [mm]
25,4 = Centre hole diameter H [mm]
A = Abrasive
40 = Grit size

Safety notes:

- Unmounted flap wheels are generally to be used with the matching clamping flanges.
- The maximum permitted peripheral speed is defined as follows:
 - Unmounted flap wheels = 50 m/s
 - Unmounted flap wheels for angle grinders = 80 m/s
 - Flap drums = 32 m/s
- The contact pressure has to be reduced significantly when the optimum rotational speed is exceeded.
- For safety reasons, the specified maximum permitted rotational speed must never be exceeded.



Accessories:

- Arbors with clamping flange
- Reducing flanges for unmounted flap wheels

PFERDVALUE:

PFERDERGONOMICS recommends unmounted flap wheels to sustainably reduce vibration and noise levels during use and to improve working comfort.



Recommended rotational speed range

Example:

FR 16550/25,4 A 80

Cutting speed: 15–30 m/s

Rotational speed: 1,700–3,400 RPM

Tool dia. [mm]	Cutting speed [m/s]						
	15	20	25	30	40	50	80
Rotational speeds [RPM]							
100	2,800	3,800	4,700	5,700	7,600	9,500	15,200
115	2,400	3,300	4,100	4,900	6,600	8,300	13,200
125	2,200	3,000	3,800	4,500	6,100	7,600	12,200
150	1,900	2,500	3,100	3,800	5,000	6,300	10,100
165	1,700	2,300	2,800	3,400	4,600	5,700	9,200
200	1,400	1,900	2,300	2,800	3,800	4,700	7,600
250	1,100	1,500	1,900	2,200	3,000	3,800	6,100

Aluminium oxide A type

For universal applications from coarse to fine grinding.

Abrasive:

Aluminium oxide A

■ Matching arbor for a diameter of 200 mm and 250 mm:

FR/VR 12/44,0 (EAN 4007220479650)

■ Please complete the description with the desired grit size.

Matching tool drives:

flexible shaft drive, straight grinder

Ordering notes:

■ Please order the matching arbor separately.

■ Matching arbor for a diameter of 100, 150 and 165 mm:

FR/VR 12/25,4 (EAN 4007220479643)

PFERDVALUE:

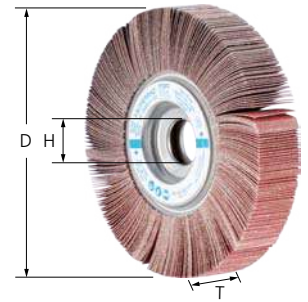

D [mm]	T [mm]	H [mm]	Grit size						Opt. RPM	Max. RPM	Box	Description	
			40	60	80	120	150	240					320
EAN 4007220													
100	30	25.4	469040	469057	469071	469095	-	-	-	5,500	9,500	2	FR 10030/25,4 A ...
	50	25.4	469187	469194	469224	469231	-	-	-	5,500	9,500	2	FR 10050/25,4 A ...
150	30	25.4	296851	296868	296875	296882	296899	-	-	3,500	6,300	2	FR 15030/25,4 A ...
	50	25.4	296905	296912	296929	296936	296943	469699	-	3,500	6,300	2	FR 15050/25,4 A ...
165	30	25.4	470091	470107	470114	470121	470138	469941	-	3,200	5,700	2	FR 16530/25,4 A ...
	50	25.4	469767	469781	469804	469811	469835	469842	469859	3,200	5,700	2	FR 16550/25,4 A ...
200	30	44	-	469606	469613	469637	-	469675	-	2,600	4,700	2	FR 20030/44,0 A ...
	50	44	-	469262	469286	469309	469323	469347	-	2,600	4,700	2	FR 20050/44,0 A ...
250	50	44	-	469064	469088	469101	469132	469156	469170	2,100	3,800	1	FR 25050/44,0 A ...

Ceramic oxide grain CO-COOL type

For aggressive grinding with maximum stock removal rate on hard materials which do not conduct heat well. Consistently high performance due to self-sharpening ceramic oxide grain.

Active grinding additives in the coating substantially improve the stock removal rate, prevent clogging and result in cooler grinding.

Abrasive:

Ceramic oxide grain CO-COOL

Ordering notes:

■ Please order the matching arbor separately.

■ Matching arbor for a diameter of 150 and 165 mm:

FR/VR 12/25,4 (EAN 4007220479643)

■ Please complete the description with the desired grit size.

Matching tool drives:

flexible shaft drive, straight grinder

PFERDVALUE:

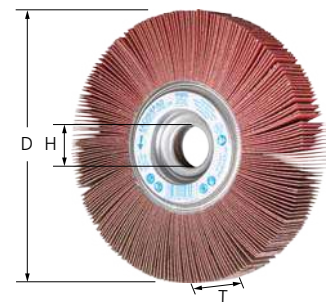

D [mm]	T [mm]	H [mm]	Grit size				Opt. RPM	Max. RPM	Box	Description
			40	60	80	120				
EAN 4007220										
150	30	25.4	104859	104873	104880	104903	3,500	6,300	2	FR 15030/25,4 CO-COOL ...
	50	25.4	105467	105474	105481	105498	3,500	6,300	2	FR 15050/25,4 CO-COOL ...
165	30	25.4	105504	105511	105528	105535	3,200	5,700	2	FR 16530/25,4 CO-COOL ...
	50	25.4	105542	105559	105566	105573	3,200	5,700	2	FR 16550/25,4 CO-COOL ...

Flap tools

Unmounted flap wheels, set FR



SET FR

Set with high-output electric straight grinder and PFERD tools for cleaning, brush matting and very fine grinding of medium-sized and large surfaces, in particular on stainless steel (INOX) components. Ideal for universal grinding work, in particular during assembly work.

Contents:

- 1 pc. each of:
 - Electric straight grinder UGER 15/60 SI with electronic rotational speed control (2,800–5,900 RPM)
 - Collet with diameter 6, 8 and 12 mm
 - Unmounted flap wheel FR 15030 A-COOL 60
 - Unmounted flap wheel FR 15030 A-COOL 120
 - POLINOX mounted flap wheel PNL 15050 A 100
 - Arbor FR/VR 12/25,4 100-165
 - Arbor PCLB 8/13/26
- 2 pcs. each of:
 - POLICLEAN wheels PCLS 15013/13

Advantages:

- Optimal, stepless rotational speed regulation for the use of unmounted flap wheels and POLINOX wheels.
- Coordinated selection of the most common versions.

Ordering notes:

- Detailed information and ordering data on tool drives can be found in catalogue section 9.

D [mm]	L x B x H [mm]	EAN 4007220		Description
150	587 x 285 x 162	777350	1	SET FR 15030 UGER 15/60 230 V

Arbors FR/VR

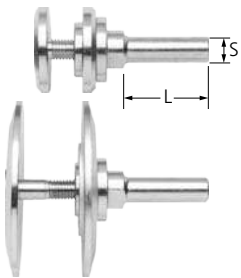

Type with clamping flange

For mounting PFERD unmounted flap wheels. The clamping flanges are designed to lie countersunk in the tool.

Advantages:

- Can be used face-down very close to edges and in angles thanks to special clamping system.

Ordering notes:

- Included in delivery: Arbor, clamping diameter of 12 mm, 2 flanges and matching screws (for different unmounted flap wheel widths).
- We manufacture arbors with morse cones on request.

Suitable for tool dia. [mm]	Suitable for centre hole dia. [mm]	S [mm]	L [mm]	Clamping width [mm]	EAN 4007220		Description
100, 150, 165	25.4	12	40	25–50	479643	1	FR/VR 12/25,4 100-165
200, 250	44	12	40	25–50	479650	1	FR/VR 12/44,0 200-250

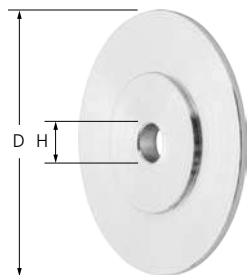

Reducing flanges for unmounted flap wheels

For mounting unmounted flap wheels and POLINOX unmounted flap wheels on drive spindles. The clamping flanges are designed to lie countersunk in the tool.

Advantages:

- Can be adapted to an existing drive spindle by drilling.
- Can be used face-down very close to edges and in angles thanks to special clamping system.

Ordering notes:

- Included in delivery: 1 pair

Suitable for tool dia. [mm]	D [mm]	H [mm]	Max. H [mm]	EAN 4007220		Description
150, 165	40	12	22.2	509876	1	RF FR 150-165 Bo. 12-22,2
200, 250	83	12	40	498460	1	RF FR 200-250 Bo. 12-40

Aluminium oxide A type

The ideal tool for use on angle grinders in assembly shop operations. For universal applications from coarse to fine grinding.

Advantages:

- Can be mounted directly on the angle grinder without additional clamping devices.

Abrasive:

Aluminium oxide A

Recommendations for use:

- For the best results, use at a recommended cutting speed of 40–50 m/s.

Matching tool drives:

angle grinder, cordless angle grinder

Ordering notes:

- Please complete the description with the desired grit size.

Safety notes:

- As a rule, unmounted flap wheels should be used with the appropriate clamping flanges for the angle grinder.

PFERDVALUE:



D [mm]	T [mm]	Thread	Grit size						Opt. RPM	Max. RPM		Description	
			40	60	80	120	180	240					320
EAN 4007220													
115	20	M14	752364	752388	752395	752401	023617	023624	023631	7,500	13,300	2	FR WS 11520 M14 A ...
		5/8-11	759417	759424	759431	759448	023679	023686	023693	7,500	13,300	2	FR WS 11520 5/8-11 A ...
125	20	M14	752418	752425	752432	752449	023648	023655	023662	6,850	12,200	2	FR WS 12520 M14 A ...
		5/8-11	847688	847701	847718	847725	023709	023716	023723	6,850	12,200	2	FR WS 12520 5/8-11 A ...

Ceramic oxide grain CO-COOL type

The ideal tool for use on angle grinders in assembly shop operations. For aggressive grinding with maximum stock removal rate on hard materials which do not conduct heat well. Consistently high performance due to self-sharpening ceramic oxide grain.

Active grinding additives in the coating substantially improve the stock removal rate, prevent clogging and result in cooler grinding.

Advantages:

- Can be mounted directly on the angle grinder without additional clamping devices.

Abrasive:

Ceramic oxide grain CO-COOL

Recommendations for use:

- For the best results, use at a recommended cutting speed of 40–50 m/s.

Matching tool drives:

angle grinder, cordless angle grinder

Ordering notes:

- Please complete the description with the desired grit size.

Safety notes:

- As a rule, unmounted flap wheels should be used with the appropriate clamping flanges for the angle grinder.

PFERDVALUE:

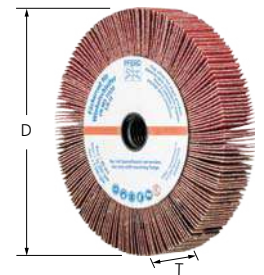

D [mm]	T [mm]	Thread	Grit size				Opt. RPM	Max. RPM		Description
			40	60	80	120				
EAN 4007220										
115	20	M14	025611	025635	025642	025659	7,500	13,300	2	FR WS 11520 M14 CO-COOL ...
		5/8-11	025697	025703	025710	025727	7,500	13,300	2	FR WS 11520 5/8-11 CO-COOL ...
125	20	M14	025628	025666	025673	025680	6,850	12,200	2	FR WS 12520 M14 CO-COOL ...
		5/8-11	025734	025741	025765	025789	6,850	12,200	2	FR WS 12520 5/8-11 CO-COOL ...



Flap tools

Flap drums

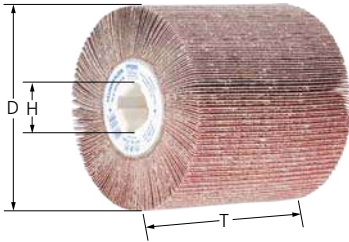

FR-W type

Can be used for universal work on medium-sized and large metallic surfaces, e.g. fine grinding work on large radii in container, kitchen and apparatus construction, and achieving homogeneous finishes (grinding patterns) on large surfaces and contours in manual applications.

Suitable for all conventional keyway systems.

Abrasive:

Aluminium oxide A

Recommendations for use:

- For the best results, use at a recommended cutting speed of 15–30 m/s.

Matching tool drives:

drum grinders

Ordering notes:

- The centre hole diameter of 19 mm with 4 wedge keyways fits on all conventional drum drives.

- Other drum tools can be found on pages 116–117 of this catalogue and in catalogue section 8.

- Please complete the description with the desired grit size.

PFERDVALUE:



D [mm]	T [mm]	H [mm]	Grit size						Opt. RPM	Max. RPM		Description
			40	60	80	120	150	180				
EAN 4007220												
100	100	19	770498	770504	770511	770528	770535	770542	3,800	6,100	1	FR-W 100100 A ...

Drums, set FR-W



SET FR-W

Set with high-output electric grinding drum drive and PFERD tools for cleaning, brush matting and very fine grinding of large surfaces on stainless steel (INOX) components.

Contents:

- 1 pc. each of:
 - Electric grinding drum drive UWER 15/40 A-SI D19 with electronic rotational speed control (900–3,500 RPM)
 - Flap drum FR-W 100100 A 80
 - POLINOX grinding drum PNL-W 100100 A 180
 - Three empty storage compartments provide space for further drum tools from the PFERD range.

Advantages:

- Optimal, stepless rotational speed regulation for the use of unmounted flap wheels and POLINOX drums.
- Coordinated selection of the most common versions.

Ordering notes:

- Detailed information and ordering data on tool drives can be found in catalogue section 9.
- Different types of wheel brushes for buffing machines can be found in catalogue section 8.

D [mm]	L x B x H [mm]	EAN 4007220		Description
100	594 x 561 x 161	777299	1	SET FR-W 100100 UWER 15/40 230 V



POLIFLAP tools are ideal for blending and restoring surface textures, fine grinding of radii, contours, curved areas or large surfaces.

Safety notes:

- The maximum permitted peripheral speed is 32 m/s.
- For safety reasons, the specified maximum permitted rotational speed must never be exceeded.



Accessories:

- POLIFLAP abrasive flaps
- POLIFLAP rubber flaps

PFERDVALUE:

PFERDERGONOMICS recommends POLIFLAP tools to sustainably reduce vibration and noise levels during use and to improve working comfort.

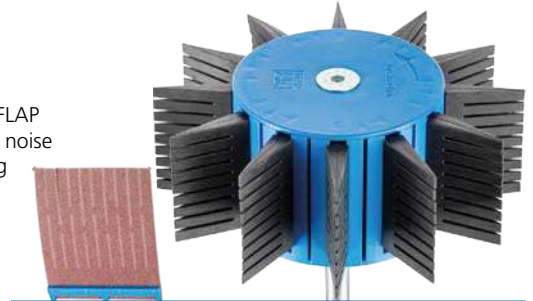

POLIFLAP tools

Grinding wheel PFL

The grinding wheel consists of a shank-mounted support and rubber flaps. It must be completed with appropriate abrasive flaps. The combination and arrangement of the abrasive and rubber flaps results in a highly flexible tool.

Advantages:

- Optimal harmonization of different surface structures.
- Creates a consistently high surface quality over the entire tool life as new, sharp abrasive is steadily released.
- Comfortable to use thanks to particularly lightweight design.

Recommendations for use:

- For optimum results on stainless steel (INOX), use at a rotational speed between 1,400–1,700 RPM.
- In the event of excessive wear, we recommend replacing the flaps early.

Matching tool drives:

flexible shaft drive, straight grinder

Ordering notes:

- Supplied without abrasive flaps. Please order abrasive flaps separately in the desired grit size.

PFERDVALUE:

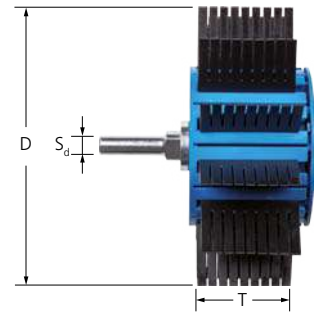

D [mm]	T [mm]	S _d [mm]	EAN 4007220	Opt. RPM	Max. RPM		Description
170	60	12	725405	1,500	3,500	1	PFL 17060/12

Abrasive flaps PFL-SL

Abrasive flaps suitable for POLIFLAP grinding wheels, for achieving visual effects ranging from coarse to very fine.

Advantages:

- Comfortable to use as easy to replace once worn.

Abrasive:

Aluminium oxide A

Ordering notes:

- The packaging unit corresponds to a complete POLIFLAP grinding wheel.
- Please complete the description with the desired grit size.

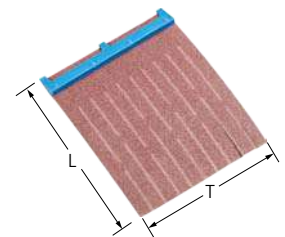

L [mm]	T [mm]	Grit size									Description
		60	80	100	120	150	180	220	320		
EAN 4007220											
75	60	725276	725283	725290	725306	725313	725320	725337	725344	12	PFL-SL A ...

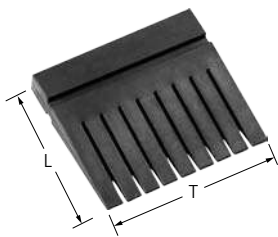

Rubber flaps PFL-GL

Rubber flaps to match the POLIFLAP grinding wheel. They lie between the abrasive flaps, and support the abrasive effect and the flexibility of the tool.

Advantages:

- Comfortable to use as easy to replace once worn.

Ordering notes:

- The packaging unit corresponds to a complete POLIFLAP grinding wheel.

L [mm]	T [mm]	EAN 4007220		Description
50	55	725412	12	PFL-GL

POLIFLAP, set PFL



SET PFL

Set with high-output electric straight grinder and PFERD tools for brush matting and for pattern blending on medium-sized and large surfaces on stainless steel (INOX) components.

Contents:

1 pc. each of:

- Electric straight grinder UGER 15/30 SI with electronic rotational speed control (750–3,000 RPM)
- Collet with diameter 6, 8 and 12 mm
- Hexagon socket wrench, 6 mm
- POLIFLAP grinding wheel PFL 17060/12 with abrasive flaps PFL-SL (grit sizes A 60, A 80, A 100, A 120, A 150, A 180, A 220, A 320)
- POLINOX mounted flap wheel PNG 10050/6 SiC 180
- Poliflex fine grinding point PF ZY 10030/8 CU 16 PU-STRUC

2 pcs. each of:

- Single-head spanner SW 22

Advantages:

- Optimal, stepless rotational speed regulation for the use of POLIFLAP tools.
- Coordinated selection of the most common versions.

Ordering notes:

- Detailed information and ordering data on tool drives can be found in catalogue section 9.

D [mm]	L x B x H [mm]	EAN 4007220		Description
170	594 x 561 x 161	777343	1	SET PFL 17060 UGER 15/30 SI 230 V



Overlap slotted discs are ideally suited to side grinding.

Safety notes:

- The maximum permitted peripheral speed is 20 m/s.
- For safety reasons, the specified maximum permitted rotational speed must never be exceeded.



Accessories:

- Arbors for overlap slotted discs

PFERDVALUE:

PFERDERGONOMICS recommends overlap slotted discs to sustainably reduce vibration and noise levels during use and to improve working comfort.

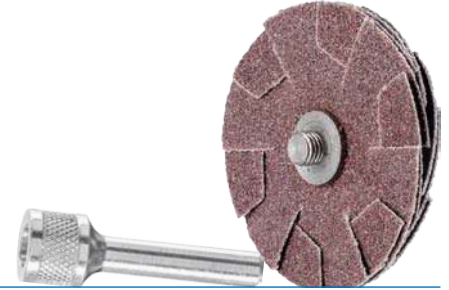

Overlap slotted discs KS

KS type

Special tool for side grinding in grooves, fillets and slots. They are mounted via a central threaded hub.



Abrasive:
Aluminium oxide A

Recommendations for use:

- Hold the tool at an angle to grind with both disc sides.

Ordering notes:

- Please order the matching arbor separately.

PFERDVALUE:



Advantages:

- Hard-to-reach areas can be accessed as the tool provides abrasive action on its top and bottom sides.
- High economic efficiency as the tool can be changed quickly.

D [mm]	T [mm]	Grit size	No. of layers	EAN 4007220	Opt. RPM	Max. RPM	Suitable arbors		Description
30	5	80	4	152706	6,500	12,000	BO KS 30	20	KS 30-4 A 80
50	5	80	4	152768	4,000	8,000	BO KS 50	20	KS 50-4 A 80

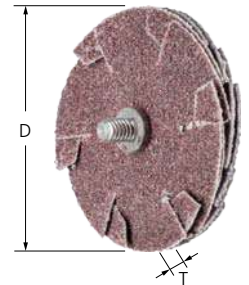

4



Arbors for overlap slotted discs BO KS

BO KS type

Matching arbor for overlap slotted discs.

Advantages:

- Reduced set-up work as the overlap slotted discs can be changed without unclamping the arbor from the collet.

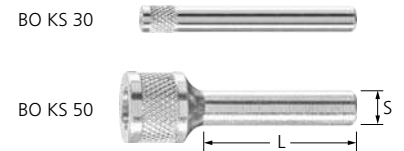

Suitable for	S [mm]	L [mm]	Thread	EAN 4007220		Description
KS 30-4 A 80	6	40	1/8 BSW	152164	1	BO KS 30
KS 50-4 A 80	6	40	1/4-28 UNF	152157	1	BO KS 50

Flap tools

General information – POLISTAR

POLISTAR flexible tools have been especially developed for work on the inner surfaces of holes and pipes.

Advantages:

- Optimum adaptation to contours thanks to high flexibility.
- Most effective work on small inner diameters, particularly in the range of 7–40 mm, due to tool dimensions.

Recommendations for use:

- For best performance, use with a recommended cutting speed of 15–20 m/s.
- POLISTAR products can be stacked in several layers. Arrange so that the layers are offset to ensure that the abrasive is applied as effectively as possible.
 - PST 20/1,6 for centre hole dia. 7–15 mm
 - PST 30/1,6 for centre hole dia. 10–20 mm
 - PST 40/3 for centre hole dia. 15–25 mm
 - PST 50/3 for centre hole dia. 20–40 mm

Matching tool drives:

- Flexible shaft drives
- Straight grinders

Ordering notes:

- Please order arbors separately.
- POLISTAR products are supplied in sheets. Sheet contents:
 - Dia. 20 and 30 mm = 25 pcs.
 - Dia. 40 and 50 mm = 10 pcs

Safety notes:

- The maximum permitted peripheral speed is 20 m/s.
- For safety reasons, the specified maximum permitted rotational speed must never be exceeded.



Accessories:

- Arbors for POLISTAR and POLISTAR-TUBE

PFERDVALUE:

PFERDERGONOMICS recommends POLISTAR to sustainably reduce vibration and noise levels during use and to improve working comfort.

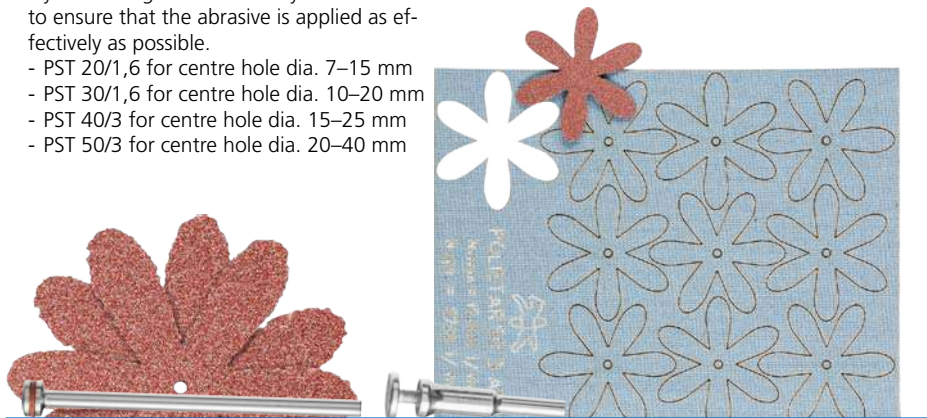

POLISTAR

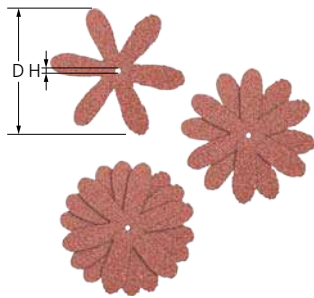

PST type

The flexible tools are particularly suitable for work on inner surfaces.

Abrasive:

Aluminium oxide A

Ordering notes:

- Please complete the description with the desired grit size.

PFERDVALUE:



D [mm]	H [mm]	Grit size			Opt. RPM	Max. RPM	Suitable arbors		Description
		60	80	120					
EAN 4007220									
20	1.6	661345	661444	661451	15,000	38,000	BO 2,3/1,6 1-5, BO 3/1,6 1-5	100	PST 20/1,6 A ...
30	1.6	661468	661482	661512	9,500	25,000	BO 2,3/1,6 1-5, BO 3/1,6 1-5	100	PST 30/1,6 A ...
40	3	661543	661550	661567	7,200	19,000	BO 6/3 1-6	100	PST 40/3,0 A ...
50	3	661574	661581	661598	5,700	15,000	BO 6/3 1-6	100	PST 50/3,0 A ...



POLISTAR-TUBE are multi-layered tools that are riveted together. They are used especially for working on the inner surfaces of pipes and pipe bends.

They are used in combination with the matching flexible shafts from catalogue section 9:

- For PST-T dia. 50–80 mm – 4 PST-T DIN 10/M4
- For PST-T dia. 90–100 mm – 7 PST-T DIN 10/M5

Advantages:

- Optimum adaptation to contours thanks to high flexibility.
- For achieving very fine surface quality grades of up to R_a 0.2 μm .
- Prevention of corrosion formation on stainless steel (INOX) pipes thanks to use of stainless steel rivets.

Recommendations for use:

- For best performance, use with a recommended cutting speed of 15–20 m/s.
- Select the tool diameter based on the respective pipe's inner diameter:
 - PST-T dia. 50 mm for inner pipe dia. 35–40 mm
 - PST-T dia. 60 mm for inner pipe dia. 40–45 mm
 - PST-T dia. 70 mm for inner pipe dia. 45–50 mm
 - PST-T dia. 80 mm for inner pipe dia. 50–55 mm
 - PST-T dia. 90 mm for inner pipe dia. 55–60 mm
 - PST-T dia. 100 mm for inner pipe dia. 60–65 mm

- Select the appropriate grit size for the desired roughness value:

- Grit size 60 = 1.0–1.3 μm R_a
- Grit size 120 = 0.6–1.0 μm R_a
- Grit size 180 = 0.4–0.6 μm R_a
- Grit size 240 = 0.3–0.4 μm R_a
- Grit size 320 = 0.2–0.3 μm R_a

Matching tool drives:

- Flexible shaft drives
- Straight grinders

Ordering notes:

- Please order arbors separately.
- PST-T with a grit size of 60 are always supplied with 4 layers.

Safety notes:

- For safety reasons, the specified maximum permitted rotational speed must never be exceeded.



Accessories:

- Arbors for POLISTAR and POLISTAR-TUBE

PFERDVALUE:

PFERDERGONOMICS recommends POLISTAR-TUBE to sustainably reduce vibration and noise levels during use and to improve working comfort.



POLISTAR-TUBE

PST-T type

The flexible tools are ideal for use in pipes and pipe bends.

Abrasive:

Aluminium oxide A

Ordering notes:

- Please complete the description with the desired grit size.

PFERDVALUE:

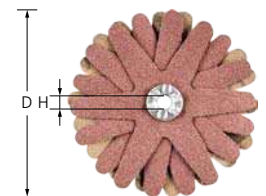

D [mm]	H [mm]	No. of layers [pcs.]	Grit size					Opt. RPM	Max. RPM	Suitable arbors		Description
			60	120	180	240	320					
EAN 4007220												
50	4	6	834398	834404	834411	834435	834442	3,000	7,650	BO 6/4 0-10	10	PST-T 50/4 6 A ...
60	4	6	834596	834718	834725	834732	834749	2,500	6,350	BO 6/4 0-10	10	PST-T 60/4 6 A ...
70	4	6	834756	834763	834770	834787	834794	2,200	5,450	BO 6/4 0-10	10	PST-T 70/4 6 A ...
80	4	6	834800	834817	834824	834831	834848	1,900	4,750	BO 6/4 0-10	10	PST-T 80/4 6 A ...
90	5	8	834855	834862	834879	834886	834893	1,700	4,250	BO 6/5 0-10	10	PST-T 90/5 8 A ...
100	5	8	834909	834916	834923	834947	834954	1,500	3,820	BO 6/5 0-10	10	PST-T 100/5 8 A ...

Flap tools

Arbor for POLISTAR and POLISTAR-TUBE

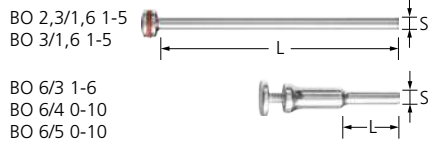

BO 2,3/1,6 1-5
BO 3/1,6 1-5

BO 6/3 1-6
BO 6/4 0-10
BO 6/5 0-10

BO type

Matching arbor for POLISTAR and POLISTAR-TUBE.

Advantages:

- High economic efficiency as the tool can be changed quickly.

Suitable for centre hole dia. [mm]	S [mm]	L [mm]	Clamping width [mm]	EAN 4007220		Description
1.6	2.34	43	1-5	151570	10	BO 2,3/1,6 1-5
	3	43	1-5	151587	10	BO 3/1,6 1-5
3	6	40	1-6	505694	1	BO 6/3 1-6
4	6	25	0-10	834343	1	BO 6/4 0-10
5	6	25	0-10	834350	1	BO 6/5 0-10

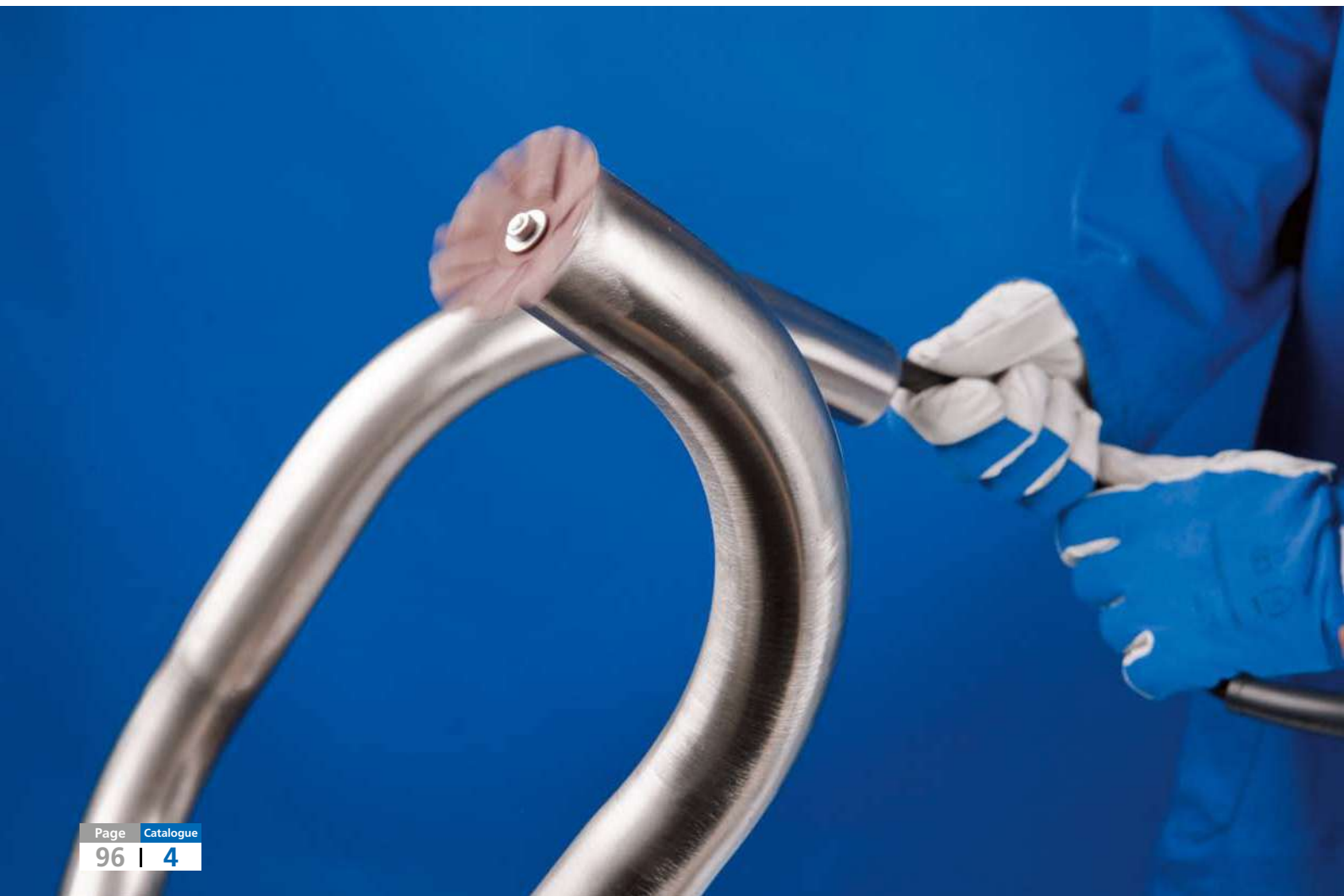

Grinding tools for work on metallic and non-metallic workpieces are sub-divided into three groups:

- **Bonded abrasives**
(e.g. grinding discs)
- **Flexible abrasives**
(e.g. belts, discs, strips, foils) These tools are used for coarse, fine and very fine grinding, in addition to stock removal.
- **Non-woven abrasives**
This group is primarily designed to realize special surface structures.

Non-woven abrasives consist of polyamide fibres, synthetic resins and abrasive grain.

The non-woven fibre structure is impregnated or interspersed with resin and abrasive grain. The very loose connection between the individual fibres ensures a high level of flexibility and gives a strong spring-type effect to the non-woven material. It is flexible and supple, and leaves behind a very distinctive surface structure.

The satin-finished grinding result is unique and cannot be achieved with other abrasives. The consistent distribution of the abrasive grain in the non-woven structure guarantees a continuous supply of new, fresh and sharp abrasive grain throughout the entire grinding application.

Although non-woven abrasives have a completely differently structure to coated abrasives, the same abrasive materials are used for both groups of tools:

- Aluminium oxide (Al_2O_3) is very durable, features an extremely long tool life and has very high aggressiveness on hardened steel. The achieved surface finish is distinguished by its increased shine. Discolouration is prevented when working on aluminium.
- Silicon carbide (SiC) is even sharper, harder and cuts very easily. In no time at all, it produces a finer grinding pattern on the surfaces of many materials which remains slightly matt for a long time.

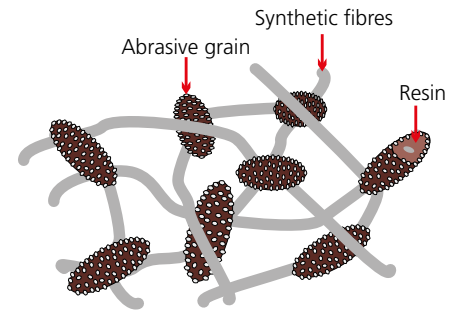

The user selects a specific grit size for conventionally bonded abrasives or coated abrasives. The designation system for non-woven abrasives is outlined in the following table:

Designation at PFERD	Comparable grit size [mesh]
Very coarse	50– 80
Coarse	80–100
Medium	100–180
Fine	180–220
Very fine	220–400



Use

The use of non-woven abrasives begins where other grinding tools reach their limits or no longer achieve the desired results. The elastic properties of the polyamide fibres and the positive effect of the non-woven abrasives result in finishing tools which produce outstanding results yet work gently.

Non-woven abrasives are water-tight, washable and very durable. They don't clog, leave no rust behind on surfaces and are non-conductive.

Non-woven abrasive can be used to outstanding effect for deburring, cleaning and for work on the surfaces of many metals, including aluminium, brass, copper, nickel, stainless steel (INOX) and titanium. It is also suitable for work on other materials which are difficult to grind, such as ceramic, glass and plastic. Non-woven abrasive can be used for wet or dry grinding.



Non-woven tools

General information



Non-woven tools

Non-woven abrasives are suitable for manufacturing a wide range of different tools, such as hand pads, drums, discs, belts, points and mounted grinding wheels.

The abrasive properties of these tools are tailored to a variety of applications and represent outstanding solutions for numerous metal machining and processing tasks.

The PFERD range comprises:

- COMBICLICK/COMBIDISC non-woven discs VRW
- Non-woven shop rolls, hand pads
- POLINOX mounted flap wheels, grinding discs, grinding wheels and grinding drums (PNL, PNZ, PNR, PNG, PNST, PNK and PNER)

Additional types







Non-woven abrasive can also be manufactured with a fabric reinforcement. The non-woven abrasive material gains considerably higher aggressiveness and stability as a result.

Fabric-reinforced, non-woven abrasive is suitable for manufacturing discs and non-woven belts.

The PFERD range comprises:

- COMBICLICK/COMBIDISC non-woven discs VRH
- POLIVLIES flap discs and self-adhesive discs
- Short and long belts, non-woven type

PFERD designation

PNER 	Thanks to different combinations of compaction, fibres, grain and the appropriate bond, this tool can be used for a wide range of surface finishing applications, from relatively coarse grinding to preparing the surface for polishing.
PNK 	The non-woven abrasive is wound around a core and foamed up. The tools can be optimized for a variety of applications by implementing different foam, fibre, grain and bond combinations. The spectrum of application ranges from fine deburring through to preparations for polishing.
PNL 	Made of radially arranged flaps of non-woven abrasive material. The flaps are very tightly packed, which achieves a longer tool life. The tool's main area of application is surface work.
PNZ 	The non-woven abrasive is arranged in multiple radial flaps, with one abrasive cloth interlayer between each set of flaps. This flap combination facilitates greater stock removal and a coarser surface finish.
PNG 	The non-woven abrasive comprises several very wavy strips of non-woven material wound around a core. The wavy structure of the non-woven material permits seamless brush matting of surfaces.
PNR 	The non-woven abrasive is arranged in multiple (axial) disc layers. Since the individual non-woven discs are not interconnected, the abrasive surface adapts easily to different workpiece contours, e.g. when working on profiles or pipes.
PNST 	The non-woven abrasive is star-shaped and stacked in layers which are connected in the centre. It offers outstanding performance, specifically when used for tight work areas such as holes, recesses and hard-to-reach places.

POLINOX unitized wheels PNER and unitized discs PNER consist of multiple heavily compressed, non-woven layers, which are bonded together by a special grain/resin system.

This particular bond results in non-woven products with a very good surface finish, high stock removal rate and long tool life. These properties are particularly apparent when deburring, blending, finishing and polishing soft metals, alloyed and high-alloy steels, in addition to titanium alloys.

Four different types are available:

Type	Colour code	Properties
Soft	W	Soft variant with outstanding adaptability. At the same time, durability, abrasive performance and very high surface quality are all maintained. Ideally suited to machining contours.
Medium-soft	MW	Medium-soft variant with increased edge strength and extended tool life, for tough blending and polishing applications. Well suited to machining contours.
Medium-hard	MH	Medium-hard variant with increased edge strength and extended tool life, for tough deburring and cleaning applications.
Hard	H	Hard variant with very high stock removal rate, good edge strength and long tool life, for tough deburring and polishing applications.



Comparison table

PFERD PNER				3M	Standard Abrasives	Norton	BIBIELLE
Type	Colour code	Abrasive	Grain				
Soft	W	SiC	Fine	EXL 2S fine	532	UW1-2SF or Nex-2SF	BUH 2SF
		A	Coarse	EXL 2A medium	521	UW1-2AM or Nex-2AM	BUH 2AM
Medium-soft	MW	SiC	Fine	EXL 4S fine or SST 3S fine	632	UW1-4SF	BUH 3SF
		A	Fine	EXL 4A fine or SST 3A fine	631	UW1-4AF	-
Medium-hard	MH	A	Fine	Cut & polish 5A fine or SST 5A fine	731	UW1-6AF or Nex-6AF	-
Hard	H	A	Fine	Cut & polish 7A medium or 9A medium	821	UW1-8AM or Nex-8AM	BUH 6AM
		A	Coarse	Cut & polish 7A coarse or 9A coarse	811	UW1-8AC or Nex-8AC	BUH 8AC



Non-woven tools

General information – POLINOX unitized wheels and discs PNER

Advantages:

- High profitability thanks to high abrasive performance and long tool life.
- For achieving very good surface quality standards.
- Perfect adaptation to contours thanks to free profiling.

Applications:

Cleaning

- Universal cleaning before painting.
- Removal of rust, scratches, coatings, heavy scaling, oxide layers of aluminium and heat discolouration.

Deburring

- Deburring of gear components, aircraft wing spars and turbine blade edges.
- Removal of heavy burrs, in addition to moderate blemishes and scratches.
- Edge breaking and rounding.

Blending

- Blending and finishing work on engine blade surfaces, turbine blades and rotor blades.
- Removal of smaller blemishes, scratches and joints on cast workpieces.

Polishing

- Polishing of fillet welds on turbine blades and aircraft parts.
- Polishing of soft metals before the coating process, and of hardened steel when repairing moulds and dies.
- Polishing and finishing of surgical instruments and implants.

Recommendations for use:

- Considerably reduce cutting speed for work on materials with poor heat-conducting properties, e.g. titanium and stainless steel.
- For best performance, use with a recommended cutting speed of 15–35 m/s. This provides an ideal compromise between stock removal rate, surface quality, thermal load on the workpiece and tool wear.

Matching tool drives:

- Flexible shaft drives
- Straight grinders
- Bench grinders

Ordering notes:

- When ordering, please state the EAN or the full description.
- **Ordering example:**
EAN 4007220355473
PNER-H 7506-6 A G
- **Ordering example explanation:**
PNER = POLINOX unitized wheels
H = Type
7506 = Outer diameter D x width T [mm]
6 = Centre hole diameter H [mm]
A = Abrasive
G = Grit size

Safety notes:

- For safety reasons, the specified maximum permitted rotational speed must never be exceeded.



Accessories:

- Arbor for POLINOX unitized wheels

PFERDVALUE:

PFERDERGONOMICS recommends POLINOX unitized wheels and unitized discs PNER to sustainably reduce vibration, noise and dust levels produced by tools and to improve working comfort.

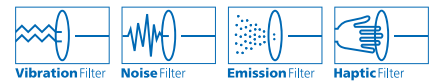

Recommended rotational speed range

Example:

PNER-H 7506-6 A G

Cutting speed: 25 m/s

Rotational speed: 6,300 RPM

Tool dia. [mm]	Cutting speed [m/s]						
	15	20	25	30	32	35	50
	Rotational speeds [RPM]						
25	11,400	15,200	19,000	22,900	24,400	26,700	38,100
50	5,700	7,600	9,500	11,400	12,200	13,300	19,000
75	3,800	5,000	6,300	7,600	8,100	8,900	12,700
100	2,800	3,800	4,700	5,700	6,100	6,600	9,500
115	2,400	3,300	4,100	4,900	5,300	5,800	8,300
125	2,200	3,000	3,800	4,500	4,800	5,300	7,600
150	1,900	2,500	3,100	3,800	4,000	4,400	6,300



PNER type

Type for straight grinders, flexible shafts and bench grinders:

Particularly suitable for work on smaller surfaces.

Type for speed-adjustable angle grinders and fillet weld grinders:

They are especially suitable for work on fillet welds and very hard-to-reach slots or indentations.

Abrasive:

Aluminium oxide A
Silicon carbide SiC

Recommendations for use:

- Grinding wheels with a diameter of 150 mm can also be used on bench grinders, for reworking surgical instruments, for example.

Ordering notes:

- An adapter is included with the 150 x 25 mm diameter grinding wheels, which allows the centre hole diameter to be reduced from 25.4 mm to 20 mm.
- Please complete the description with the desired hardness grade.



PFERDVALUE:



D [mm]	T [mm]	H [mm]	Grit size	Abra-sives	Type				Opt. RPM	Max. RPM	Suitable arbors		Description
					W (soft)	MW (medium-soft)	MH (medium-hard)	H (hard)					
EAN 4007220													

Type for straight grinders, flexible shafts and bench grinders

25	25	6	coarse	A	-	-	-	440438	19,000	30,500	BO PNER 25 S6	10	PNER-... 2525-6 A G
			fine	A	-	-	440452	440445	19,000	30,500	BO PNER 25 S6	10	PNER-... 2525-6 A F
50	3	6	fine	A	-	-	-	505700	9,500	15,300	BO 6/6 3-10	10	PNER-... 5003-6 A F
			fine	A	-	-	-	505717	6,400	10,200	BO 6/6 3-10	10	PNER-... 7503-6 A F
75	3	6	coarse	A	476307	-	-	355473	6,400	10,200	BO 6/6 3-10	5	PNER-... 7506-6 A G
			fine	A	-	355534	355503	-	6,400	10,200	BO 6/6 3-10	5	PNER-... 7506-6 A F
			fine	SiC	355626	355558	-	-	6,400	10,200	BO 6/6 3-10	5	PNER-... 7506-6 SiC F
			coarse	A	476314	-	-	355480	6,400	10,200	BO 6/6 3-10	5	PNER-... 7513-6 A G
			fine	A	-	355565	355510	-	6,400	10,200	BO 6/6 3-10	5	PNER-... 7513-6 A F
			fine	SiC	476338	355589	-	-	6,400	10,200	BO 6/6 3-10	5	PNER-... 7513-6 SiC F
150	25	25.4	coarse	A	-	-	-	355497	3,200	5,100	BO 12/20 10-50	1	PNER-... 15025-25,4 A G
			fine	A	-	476291	355527	-	3,200	5,100	BO 12/20 10-50	1	PNER-... 15025-25,4 A F
			fine	SiC	355633	355602	-	-	3,200	5,100	BO 12/20 10-50	1	PNER-... 15025-25,4 SiC F

Type for angle grinders and fillet weld grinders

125	6	22.23	coarse	A	-	-	-	833179	4,500	6,100	-	5	PNER-... 12506-22,2 A G
			fine	A	-	833148	833155	833162	4,500	6,100	-	5	PNER-... 12506-22,2 A F
			fine	SiC	-	833131	-	-	4,500	6,100	-	5	PNER-... 12506-22,2 SiC F
150	3	25.4	fine	A	-	-	-	895733	3,800	5,100	-	5	PNER-... 15003-25,4 A F
			fine	SiC	-	895719	895726	-	3,800	5,100	-	5	PNER-... 15003-25,4 SiC F
			fine	A	-	-	-	895764	3,800	5,100	-	5	PNER-... 15006-25,4 A F
			fine	SiC	895740	895757	-	-	3,800	5,100	-	5	PNER-... 15006-25,4 SiC F



Non-woven tools

Arbors for POLINOX unitized/convolute wheels

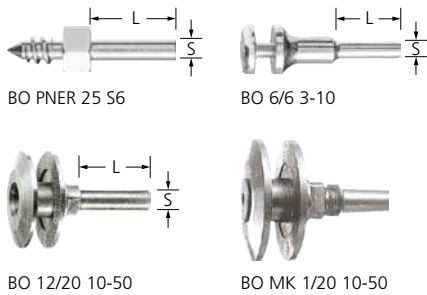

Arbors BO

Matching arbor for POLINOX unitized wheels.

Advantages:

- High economic efficiency as the tool can be changed quickly.

Suitable for centre hole dia. [mm]	S [mm]	L [mm]	Clamping width [mm]	EAN 4007220		Description
6	6	25	-	440469	1	BO PNER 25 S6
			3-10	297650	1	BO 6/6 3-10
20	12	35	10-50	297674	1	BO 12/20 10-50
	-	-	10-50	297681	1	BO MK 1/20 10-50

POLINOX unitized discs PNER



PNER discs

POLINOX unitized discs are used for face-down grinding on speed-adjustable angle grinders. Especially well-suited to work on larger surfaces. The compressed, non-woven material is bonded to a glass-fabric base.

Abrasive:

Silicon carbide SiC

PFERDVALUE:

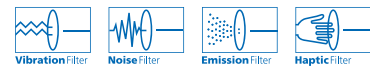

D [mm]	T [mm]	H [mm]	Grit size	Type	Abrasives	EAN 4007220	Opt. RPM	Max. RPM		Description
115	13	22.23	fine	soft	SiC	824337	6,000	10,000	5	DISC PNER-W 115-22,2 SiC F
				medium-soft	SiC	824344	6,000	10,000	5	DISC PNER-MW 115-22,2 SiC F
				medium-hard	SiC	824351	6,000	10,000	5	DISC PNER-MH 115-22,2 SiC F
125	13	22.23	fine	soft	SiC	824368	5,400	10,000	5	DISC PNER-W 125-22,2 SiC F
				medium-soft	SiC	824375	5,400	10,000	5	DISC PNER-MW 125-22,2 SiC F
				medium-hard	SiC	824382	5,400	10,000	5	DISC PNER-MH 125-22,2 SiC F



SET PNER

Set with handy electric fillet weld grinder and PFERD tools for brushing, cleaning, weld dressing and very fine grinding of fillet welds and hard-to-reach places on stainless steel (INOX) components.

Contents:

1 pc. each of:

- Electric fillet weld grinder
KNER 5/34 V-SI with electronic rotational speed control (1,400–3,200 RPM)
- POLINOX unitized wheels:
 - PNER-MW 15003-25,4 SiC F
 - PNER-MH 15003-25,4 SiC F
 - PNER-H 15003-25,4 A F
 - PNER-W 15006-25,4 SiC F
 - PNER-MW 15006-25,4 SiC F
 - PNER-H 15006-25,4 A F
- Dressing stone SE 702212 CU 46 M5V
- POLINOX discs:
 - PVR 15008-13 A 100
 - PVR 15008-13 A 280
- Wheel brush RBU 15016/12,0 SiC 80 1,00 incl. arbor hole adapter 22.2 mm

Advantages:

- Optimal, stepless rotational speed regulation for the use of different tools.
- Coordinated selection of the most common versions.

Recommendations for use:

- Please note the different recommended rotational speeds: POLINOX unitized wheels PNER = 2,000–3,800 RPM; POLINOX discs PVR = 1,500–3,100 RPM; wheel brush RBU = 2,400–3,900 RPM

Ordering notes:

- Detailed information and ordering data on tool drives can be found in catalogue section 9.

PFERDVALUE:



D [mm]	L x B x H [mm]	EAN 4007220		Description
150	587 x 285 x 162	936306	1	SET PNER 15003/06 KNER 5/34 230 V



Non-woven tools





General information – POLINOX convolute wheels PNK







POLINOX convolute wheels PNK consist of spiral-shaped, non-woven abrasive which is wound around a core and foamed up. The foam supports the non-woven component and positively impacts its tool life and abrasive performance.

This particular bond results in non-woven wheels with a very good surface finish, high stock removal rate and long tool life. These properties are particularly apparent when deburring, blending, finishing and polishing soft metals, alloyed and high-alloy steels, in addition to titanium alloys. The wheels can be used on automated appliances and bench grinders, in addition to portable tool drives such as straight grinders. By dressing the wheels, they can also be adapted to the geometry of special workpieces.

Five different types are available:

Type	Colour code	Properties
Soft		Soft variant with very good abrasive performance on contours. Very good for blending surfaces.
Medium-soft		Medium-soft variant with increased flexibility and extended tool life for tough blending applications and for light deburring and polishing work. Well suited to machining contours.
Medium-hard		Medium-hard variant with increased edge strength and extended tool life, for tough deburring applications and other deburring, blending and cleaning work.
Hard		Hard variant with very high stock removal rate, good edge strength and long tool life, for moderate to heavy-duty deburring and polishing applications.
Extra-hard		Extra-hard variant with very high edge strength for demanding deburring work.

Comparison table

PFERD PNK				3M	Standard Abrasives	Norton	BIBIELLE
Type	Colour code	Abrasive	Grain				
Soft		A	Coarse	CP-WL 5AM	MF CV 5AM	MF CF 5AM	BCW-MF 5AM
Medium-soft		SiC	Fine	LDW 7SF	LDW 7SF	Series 2000 7SF	BCW-DB 7SF
Medium-hard		SiC	Fine	EXL Deburring 8SF	Deburring 8SF	Series 1000 8SF	BCW-DB 8SF
		A	Coarse	EXL Deburring 8AM	GP Plus 8AM	Series 1000 8AM	BCW-DB 8AM
Hard		SiC	Fine	Deburring 9SF	EXL Deburring 9SF	Series 1000 9SF	BCW-DB 9SF
Extra-hard		SiC	Fine	XP-WL 10SF	GP Plus 10SF	Series 4000 9SF	BCW-DB 9SF-R



Advantages:

- High profitability thanks to high abrasive performance and long tool life.
- For achieving very good surface quality standards.
- Perfect adaptation to contours thanks to free profiling.

Abrasive:

- Aluminium oxide A
- Silicon carbide SiC

Applications:

- Rounding of edges.
- Fine grinding of implants.
- Matt finishing of flat surfaces.
- Removing joints on cast and forged parts.
- Weld dressing of intersections on turbine blades.
- Polishing moulds and dies.
- Removal of processing traces on surgical instruments.

Recommendations for use:

- Considerably reduce cutting speed for work on materials with poor heat-conducting properties, e.g. titanium and stainless steel.
- For best performance, use with a recommended cutting speed of 20 m/s. This provides an ideal compromise between stock removal rate, surface quality, thermal load on the workpiece and tool wear.

Recommended rotational speed range

Example:

PNK-MW 15013-25.4 SiC F
Cutting speed: 20 m/s

Rotational speed: 2,500 RPM

Matching tool drives:

- Flexible shaft drives
- Straight grinders
- Bench grinders

Safety notes:

- For safety reasons, the specified maximum permitted rotational speed must never be exceeded.
- The wound construction of the tool requires that the indicated tool running direction is strictly adhered to. Non-compliance with the tool running direction will lead to destruction of the tool, and carries an increased risk of accidents.



PFERDVALUE:

PFERDERGONOMICS recommends POLINOX convolute wheels PNK to sustainably reduce vibration, noise and dust levels produced by tools and to improve working comfort.

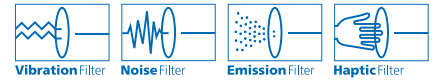

4



Tool dia. [mm]	Cutting speed [m/s]				
	15	20	25	30	40
Rotational speeds [RPM]					
150	1,900	2,500	3,100	3,800	5,000
200	1,400	1,900	2,300	2,800	3,800
250	1,100	1,500	1,900	2,200	3,000



Non-woven tools

POLINOX convolute wheels PNK



PNK type

Varied application options, for example:

- Rounding of edges
- Fine grinding of implants
- Weld dressing of intersections on turbine blades
- Removal of processing traces on surgical instruments

They create matt surface finishes.

Abrasive:

- Aluminium oxide A
- Silicon carbide SiC

PFERDVALUE:

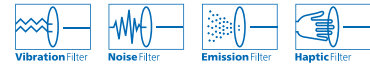

D [mm]	T [mm]	H [mm]	Grit size	Type	Abrasives	EAN 4007220	Opt. RPM	Max. RPM		Description		
150	13	25.4	fine	medium-soft	SiC	841846	2,500	5,100	1	PNK-MW 15013-25,4 SiC F		
			fine	medium-hard	SiC	841860	2,500	5,100	1	PNK-MH 15013-25,4 SiC F		
			coarse	medium-hard	A	841853	2,500	5,100	1	PNK-MH 15013-25,4 A G		
			fine	hard	SiC	841877	2,500	5,100	1	PNK-H 15013-25,4 SiC F		
			fine	extra-hard	SiC	091357	2,500	5,100	1	PNK-EH 15013-25,4 SiC F		
			coarse	soft	A	896501	2,500	5,100	1	PNK-W 15025-25,4 A G		
	200	25	76.2	fine	medium-soft	SiC	841884	2,500	5,100	1	PNK-MW 15025-25,4 SiC F	
				fine	medium-hard	SiC	841907	2,500	5,100	1	PNK-MH 15025-25,4 SiC F	
				coarse	medium-hard	A	841891	2,500	5,100	1	PNK-MH 15025-25,4 A G	
				fine	hard	SiC	841914	2,500	5,100	1	PNK-H 15025-25,4 SiC F	
				fine	extra-hard	SiC	091395	2,500	5,100	1	PNK-EH 15025-25,4 SiC F	
				coarse	soft	A	896501	2,500	5,100	1	PNK-W 15025-25,4 A G	
200		13	76.2	fine	medium-soft	SiC	841921	1,900	3,850	1	PNK-MW 20013-76,2 SiC F	
				fine	medium-hard	SiC	841945	1,900	3,850	1	PNK-MH 20013-76,2 SiC F	
				coarse	medium-hard	A	841938	1,900	3,850	1	PNK-MH 20013-76,2 A G	
				fine	hard	SiC	841952	1,900	3,850	1	PNK-H 20013-76,2 SiC F	
				fine	extra-hard	SiC	067819	1,900	3,850	1	PNK-EH 20013-76,2 SiC F	
				coarse	soft	A	091333	1,900	3,850	1	PNK-W 20025-76,2 A G	
		200	25	76.2	fine	medium-soft	SiC	841969	1,900	3,850	1	PNK-MW 20025-76,2 SiC F
					fine	medium-hard	SiC	841983	1,900	3,850	1	PNK-MH 20025-76,2 SiC F
					coarse	medium-hard	A	841976	1,900	3,850	1	PNK-MH 20025-76,2 A G
					fine	hard	SiC	841990	1,900	3,850	1	PNK-H 20025-76,2 SiC F
					fine	extra-hard	SiC	067765	1,900	3,850	1	PNK-EH 20025-76,2 SiC F
					coarse	soft	A	896525	1,900	3,850	1	PNK-W 20050-76,2 A G
50	76.2		31.8	fine	medium-soft	SiC	842003	1,900	3,850	1	PNK-MW 20050-76,2 SiC F	
				fine	medium-hard	SiC	842027	1,900	3,850	1	PNK-MH 20050-76,2 SiC F	
				coarse	medium-hard	A	842010	1,900	3,850	1	PNK-MH 20050-76,2 A G	
				fine	hard	SiC	842034	1,900	3,850	1	PNK-H 20050-76,2 SiC F	
				fine	extra-hard	SiC	067758	1,900	3,850	1	PNK-EH 20050-76,2 SiC F	
				coarse	soft	A	896525	1,900	3,850	1	PNK-W 20050-76,2 A G	

Clamping flanges for POLINOX convolute wheels PNK

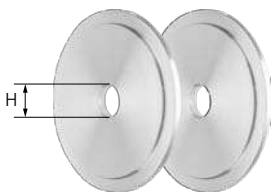

RF PNK

For mounting POLINOX convolute wheels PNK with a diameter of 200 mm on stationary machines such as double grinding machines (bench grinders).

Advantages:

- High accuracy of fit.
- Hole can be expanded as desired.

Ordering notes:

- Included in delivery: 1 pair

Suitable for centre hole dia. [mm]	H [mm]	EAN 4007220		Description
76.2	16.1	880623	1	RF PNK 200 Bo. 16,1
	25.4	880630	1	RF PNK 200 Bo. 25,4
	31.8	880647	1	RF PNK 200 Bo. 31,8

POLINOX mounted and unmounted grinding wheels and cross buffs consist of non-woven polyamide abrasive, into which abrasive grain is integrated.

The wide range of hardness grades and different tool designs allow a variety of surface structures and roughness levels to be achieved.

Advantages:

- Optimum adaptation to contours thanks to high flexibility.
- Cool grinding and low thermal load of the workpiece.
- No tool clogging due to open structure and high flexibility of the non-woven material.

Recommendations for use:

- For best performance, use with a recommended cutting speed of 10–20 m/s. This provides an ideal compromise between stock removal rate, surface quality, thermal load on the workpiece and tool wear.

Ordering notes:

- When ordering, please state the EAN or the full description.
- **Ordering example:**
 EAN 4007220157060
 PNL 4020/6 A 100
- **Ordering example explanation:**
 PNL = POLINOX mounted grinding wheel
 4020 = Outer diameter D x width T [mm]
 6 = Shank diameter S_d [mm]
 A = Abrasive
 100 = Grit size

Recommended rotational speed range

Example:

PNL 6050/6 A 100
 Cutting speed: 15 m/s
Rotational speed: 4,700 RPM

Accessories:

- Arbors for POLINOX cross buffs and unmounted flap wheels

Safety notes:

- The maximum permitted peripheral speed is 32 m/s.
- For safety reasons, the specified maximum permitted rotational speed must never be exceeded.



PFERDVALUE:

PFERDERGONOMICS recommends POLINOX mounted and unmounted grinding wheels to sustainably reduce vibration and noise levels during use and to improve working comfort.



Tool dia. [mm]	Cutting speed [m/s]				
	10	15	20	30	32
	Rotational speeds [RPM]				
30	6,300	9,500	12,700	19,000	20,300
40	4,700	7,100	9,500	14,300	15,200
50	3,800	5,700	7,600	11,400	12,200
60	3,100	4,700	6,300	9,500	10,100
100	1,900	2,800	3,800	5,700	6,100
125	1,500	2,200	3,000	4,500	4,800
150	1,200	1,900	2,500	3,800	4,000
200	900	1,400	1,900	2,800	3,000



Non-woven tools

POLINOX mounted grinding wheels

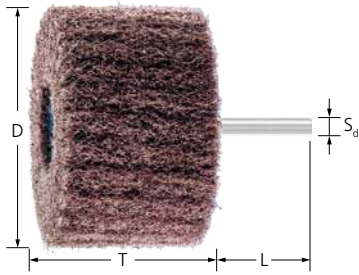

PNL type

Made of radially arranged flaps of non-woven abrasive material. A long tool life is achieved through the dense packing of the flaps.

The tool is particularly used for surface work.

Abrasive:

Aluminium oxide A
Silicon carbide SiC

Matching tool drives:

flexible shaft drive, straight grinder

Ordering notes:

■ Please complete the description with the desired grit size.

PFERDVALUE:



D [mm]	T [mm]	S _d [mm]	L [mm]	Grit size			Opt. RPM	Max. RPM		Description
				100	180	280				

EAN 4007220

Aluminium oxide A

30	25	6	40	087824	087831	087923	10,000	20,000	10	PNL 3025/6 A ...
40	20	6	40	157060	157077	157084	7,500	15,000	10	PNL 4020/6 A ...
50	30	6	40	157107	157114	157121	6,000	12,000	10	PNL 5030/6 A ...
60	25	6	40	892879	892886	892893	5,000	10,000	10	PNL 6025/6 A ...
	50	6	40	157213	157220	157237	5,000	10,000	10	PNL 6050/6 A ...
80	25	6	40	892978	892992	893005	4,000	7,500	10	PNL 8025/6 A ...
	50	6	40	157183	157190	157206	4,000	7,500	10	PNL 8050/6 A ...

Silicon carbide (SiC)

40	20	6	40	803455	293669	293676	7,500	15,000	10	PNL 4020/6 SiC ...
50	30	6	40	803493	293683	293690	6,000	12,000	10	PNL 5030/6 SiC ...
60	50	6	40	803509	293706	293713	5,000	10,000	10	PNL 6050/6 SiC ...
80	50	6	40	803516	293720	293737	4,000	7,500	10	PNL 8050/6 SiC ...

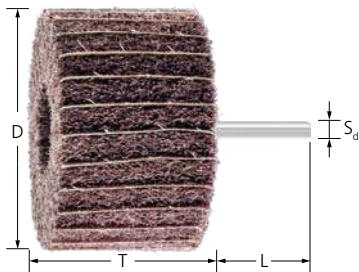

PNZ type

The non-woven abrasive material is arranged in multiple radial flaps, with abrasive cloth inter-layers.

This flap structure facilitates improved stock removal and achieves a coarser surface finish.

Abrasive:

Aluminium oxide A
Silicon carbide SiC

Matching tool drives:

flexible shaft drive, straight grinder

Ordering notes:

■ Please complete the description with the desired grit size.

PFERDVALUE:



D [mm]	T [mm]	S _d [mm]	L [mm]	Grit size		Opt. RPM	Max. RPM		Description
				100	180				

EAN 4007220

Aluminium oxide A

30	25	6	40	087930	088067	10,000	20,000	10	PNZ 3025/6 A ...
40	20	6	40	157053	294697	7,500	15,000	10	PNZ 4020/6 A ...
50	30	6	40	803158	803165	6,000	12,000	10	PNZ 5030/6 A ...
60	25	6	40	892909	892916	5,000	10,000	10	PNZ 6025/6 A ...
	50	6	40	157138	294703	5,000	10,000	10	PNZ 6050/6 A ...
80	25	6	40	893012	893029	4,000	7,500	10	PNZ 8025/6 A ...
	50	6	40	157176	294710	4,000	7,500	10	PNZ 8050/6 A ...
100	50	6	40	294666	294673	3,000	6,000	5	PNZ 10050/6 A ...

Silicon carbide (SiC)

80	50	6	40	617571	617588	4,000	7,500	10	PNZ 8050/6 SiC ...
----	----	---	----	--------	--------	-------	-------	----	--------------------

PNG type

Made of several very wavy arranged strips of non-woven abrasive material, wound around a core.

The wavy structure of the non-woven abrasive material permits seamless brush matting of surfaces.

Abrasive:

Aluminium oxide A
Silicon carbide SiC

Matching tool drives:

flexible shaft drive, straight grinder

Ordering notes:

■ Please complete the description with the desired grit size.

PFERDVALUE:

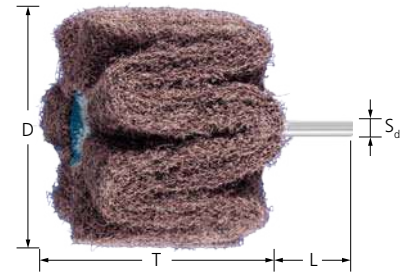

D [mm]	T [mm]	S _d [mm]	L [mm]	Grit size			Opt. RPM	Max. RPM		Description
				100	180	280				
				EAN 4007220						
Aluminium oxide A										
80	50	6	40	737989	737996	738009	4,000	7,500	10	PNG 8050/6 A ...
100	50	6	40	499580	499597	499603	3,000	6,000	5	PNG 10050/6 A ...
Silicon carbide (SiC)										
80	50	6	40	738016	738023	803639	4,000	7,500	10	PNG 8050/6 SiC ...
100	50	6	40	617595	617601	803646	3,000	6,000	5	PNG 10050/6 SiC ...

PNR type

The non-woven abrasive material is arranged in multiple (axial) disc layers.

Since the individual non-woven discs are not interconnected, the abrasive surface adapts easily to different workpiece contours, e.g. when working on profiles or pipes.

Abrasive:

Aluminium oxide A

Matching tool drives:

flexible shaft drive, straight grinder

Ordering notes:

■ Please complete the description with the desired grit size.

PFERDVALUE:

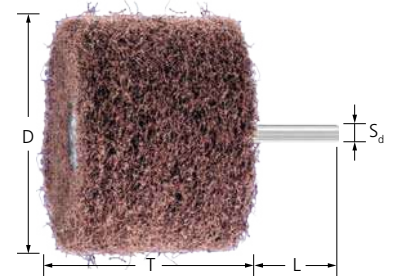

D [mm]	T [mm]	S _d [mm]	L [mm]	Grit size			Opt. RPM	Max. RPM		Description
				100	180	280				
				EAN 4007220						
Shank dia. 2.35 mm										
25	15	2.35	40	034705	034712	034729	7,600	12,300	10	PNR 2515/2,35 A ...
Shank dia. 3 mm										
25	15	3	40	034736	034743	034750	7,600	12,300	10	PNR 2515/3 A ...
30	20	3	40	034767	034774	034781	6,500	10,200	10	PNR 3020/3 A ...
Shank dia. 6 mm										
60	50	6	40	157145	157152	157169	5,000	10,000	10	PNR 6050/6 A ...
80	50	6	40	157244	157251	157268	4,000	7,500	10	PNR 8050/6 A ...



Non-woven tools

POLINOX cross buffs PNST and arbors BO PNST

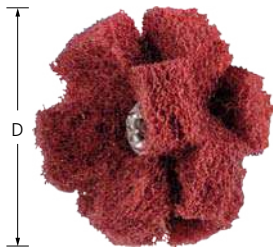

PNST type

Suitable for cleaning, deburring and fine grinding of inner surfaces and contours. Particularly suitable for hard-to-reach places such as drilled holes and indentations.

Abrasive:

Aluminium oxide A

Matching tool drives:

flexible shaft drive, straight grinder

Ordering notes:

- Please order the matching arbor separately.
- Please complete the description with the desired grit size.

PFERDVALUE:



D [mm]	No. of layers [pcs.]	Grit size			Opt. RPM	Max. RPM		Description
		80	100	280				
		EAN 4007220						
19	2	-	899199	899205	15,000	25,100	20	PNST 19-2 A ...
25	2	899212	441138	441145	10,000	19,100	20	PNST 25-2 A ...
38	3	899229	441152	441169	7,500	12,600	20	PNST 38-3 A ...
50	2	899410	899427	899434	5,500	9,500	20	PNST 50-2 A ...

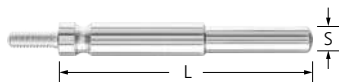

BO PNST

Arbors for POLINOX cross buffs. Both arbors are of different lengths, thus allowing holes or cut-outs of different depths to be reached.

Advantages:

- High economic efficiency as the tool can be changed quickly.

S [mm]	L [mm]	Thread	Mounting length [mm]	EAN 4007220		Description
6	75	8-32 UNC	30	440988	1	BO PNST 6-75
	125	8-32 UNC	30	440995	1	BO PNST 6-125

POLINOX, set PNL/Z/R



SET PNL/Z/R

Set with high-output electric straight grinder and PFERD tools for cleaning, brush matting and very fine grinding of small and medium-sized surfaces on stainless steel (INOX) components.

Contents:

- Electric straight grinder UGER 5/90 SI with electronic rotational speed control (4,000–9,000 RPM)
- 2 different mounted flap wheels
- 10 POLINOX mounted grinding wheels in different types and grit sizes
- POLIFAN flap disc PFC 115 A-COOL 60 SG INOX+ALU

Advantages:

- Optimal, stepless rotational speed regulation for the use of different tools.
- Coordinated selection of the most common versions.

Ordering notes:

- Detailed information and ordering data on tool drives can be found in catalogue section 9.

PFERDVALUE:



D [mm]	EAN 4007220		Description
60	323274	1	SET PNL/Z/R 6050 UGER 5/90 230 V

PNL type

Made of radially arranged flaps of non-woven abrasive material. A long tool life is achieved through the dense packing of the flaps.

This tool is mainly used for work on large surfaces.

Abrasive:

Aluminium oxide A

Matching tool drives:

flexible shaft drive, straight grinder, bench grinder

Ordering notes:

- Please order the matching arbor separately.
- Please complete the description with the desired grit size.

PFERDVALUE:

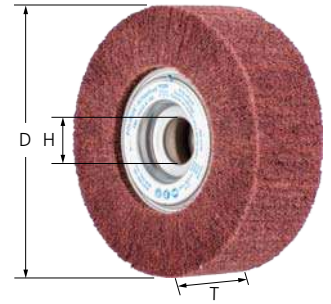

D [mm]	T [mm]	H [mm]	Grit size			Opt. RPM	Max. RPM	Suitable arbors		Description
			100	180	280					
EAN 4007220										
150	50	25.4	479667	479674	479681	2,000	4,000	FR/VR 12/25,4	1	PNL 15050/25,4 A ...
200	50	44	479698	479704	479711	1,500	3,000	FR/VR 12/44,0	1	PNL 20050/44 A ...

PNZ type

The non-woven abrasive material is arranged in multiple radial flaps, with abrasive cloth interlayers.

This flap structure facilitates improved stock removal and achieves a coarser surface finish.

This tool is mainly used for work on large surfaces.

Abrasive:

Aluminium oxide A

Matching tool drives:

flexible shaft drive, straight grinder, bench grinder

Ordering notes:

- Please order the matching arbor separately.
- Please complete the description with the desired grit size.

PFERDVALUE:

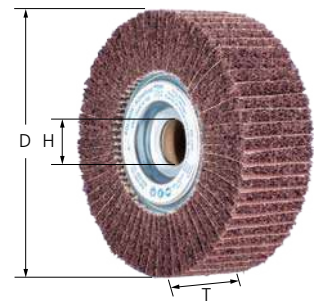

D [mm]	T [mm]	H [mm]	Grit size		Opt. RPM	Max. RPM	Suitable arbors		Description
			100	180					
EAN 4007220									
150	50	25.4	479728	479735	2,000	4,000	FR/VR 12/25,4	1	PNZ 15050/25,4 A ...
200	50	44	479759	479766	1,500	3,000	FR/VR 12/44,0	1	PNZ 20050/44 A ...



Non-woven tools

POLINOX unmounted grinding wheels

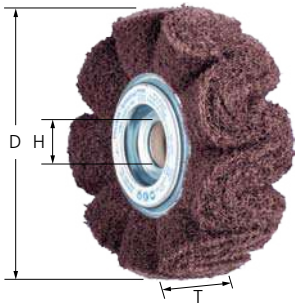

PNG type

Made of several very wavyly arranged strips of non-woven abrasive material, wound around a core.

The wavy structure of the non-woven abrasive material permits seamless brush matting of surfaces.

Abrasive:
Aluminium oxide A

Matching tool drives:
flexible shaft drive, straight grinder, bench grinder

Ordering notes:

- Please order the matching arbor separately.
- Please complete the description with the desired grit size.

PFERDVALUE:



D [mm]	T [mm]	H [mm]	Grit size			Opt. RPM	Max. RPM	Suitable arbors		Description
			100	180	280					
			EAN 4007220							
150	50	25.4	479780	479797	479803	2,000	4,000	FR/VR 12/25,4	1	PNG 15050/25,4 A ...
200	50	44	479810	479827	479834	1,500	3,000	FR/VR 12/44,0	1	PNG 20050/44 A ...

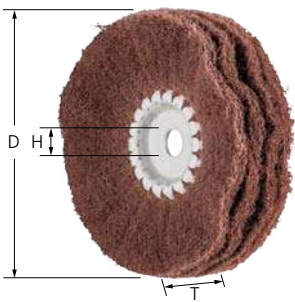

PNR type

Made of several slightly wavyly arranged strips of non-woven abrasive material, wound around a metal core.

The open arrangement and high flexibility of the non-woven abrasive material enables exceptional adaptation to contours. Suitable for seamless brush matting of surfaces, profiles and pipes.

Abrasive:
Aluminium oxide A

Matching tool drives:
flexible shaft drive, straight grinder, bench grinder

Ordering notes:

- Please order the matching arbor separately.
- Please complete the description with the desired grit size.

PFERDVALUE:



D [mm]	T [mm]	H [mm]	Grit size		Opt. RPM	Max. RPM	Suitable arbors		Description
			180	280					
			EAN 4007220						
100	35	10	293546	293560	2,500	5,500	BO 8/10 6-20	1	PNR 10035/10 A ...
150	40	20	293577	293584	2,000	4,000	BO 12/20 10-50, BO MK 1/20 10-50	1	PNR 15040/20 A ...



Arbors

Matching arbor for POLINOX unmounted grinding wheels.

Advantages:

- High economic efficiency as the tool can be changed quickly.

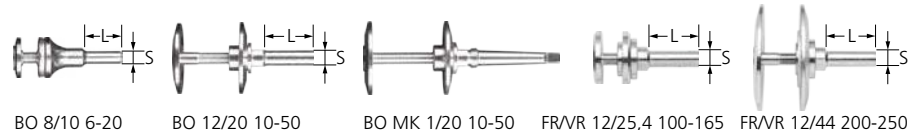

BO 8/10 6-20 BO 12/20 10-50 BO MK 1/20 10-50 FR/VR 12/25,4 100-165 FR/VR 12/44 200-250

Suitable for centre hole dia. [mm]	S [mm]	L [mm]	Clamping width [mm]	EAN 4007220		Description
10	8	30	6-20	297667	1	BO 8/10 6-20
20	12	35	10-50	297674	1	BO 12/20 10-50
	-	-	10-50	297681	1	BO MK 1/20 10-50
25.4	12	40	25-50	479643	1	FR/VR 12/25,4 100-165
44	12	40	25-50	479650	1	FR/VR 12/44,0 200-250

Reducing flanges for POLINOX grinding wheels FR

RF FR

For mounting unmounted flap wheels and POLINOX unmounted grinding wheels on drive spindles.

The clamping flanges are designed to lie countersunk in the tool.

Advantages:

- Can be adapted to an existing drive spindle by drilling.
- Can be used face-down very close to edges and in angles thanks to special clamping system.

Ordering notes:

- Included in delivery: 1 pair

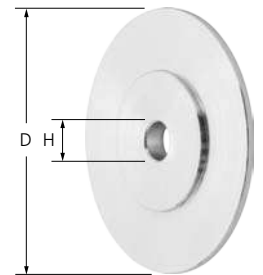

Suitable for tool dia. [mm]	D [mm]	H [mm]	Max. H [mm]	EAN 4007220		Description
150	40	12	22.2	509876	1	RF FR 150-165 Bo. 12-22,2
200	83	12	40	498460	1	RF FR 200-250 Bo. 12-40

POLINOX unmounted grinding wheels with thread

PNL type

Made of radially arranged flaps of non-woven abrasive material. A long tool life is achieved through the dense packing of the flaps.

The tool is designed for working on medium-sized surfaces with speed-adjustable angle grinders and fillet weld grinders, and can be mounted directly onto the drive system's spindle without the need for additional clamping devices.

Abrasive:

Aluminium oxide A

Ordering notes:

- Please complete the description with the desired grit size.

Matching tool drives:

angle grinder, cordless angle grinder

PFERDVALUE:

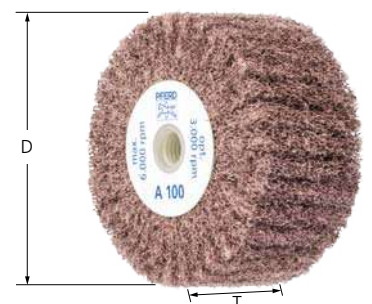

D [mm]	T [mm]	Thread	Grit size			Opt. RPM	Max. RPM		Description
			100	180	280				
EAN 4007220									
100	50	M14	003329	003336	003343	3,000	6,000	5	PNL 10050 M14 A ...
		5/8-11	003367	003374	003381	3,000	6,000	5	PNL 10050 5/8-11 A ...

Non-woven tools

POLINOX unmounted grinding wheels with thread

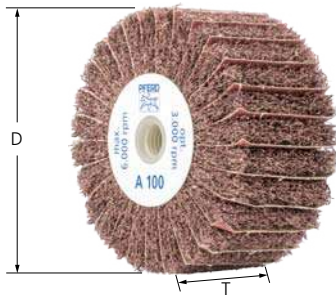

PNZ type

The non-woven abrasive material is arranged in multiple radial flaps, with abrasive cloth inter-layers. This flap structure facilitates improved stock removal and achieves a coarser surface finish.

The tool is designed for working on medium-sized surfaces with speed-adjustable angle grinders and fillet weld grinders, and can be mounted directly onto the drive system's spindle without the need for additional clamping devices.

Abrasive:
Aluminium oxide A

Matching tool drives:
angle grinder, cordless angle grinder

Ordering notes:

■ Please complete the description with the desired grit size.

PFERDVALUE:



D [mm]	T [mm]	Thread	Grit size			Opt. RPM	Max. RPM		Description
			100	180					
			EAN 4007220						
100	50	M14	003411	003428	3,000	6,000	5	PNZ 10050 M14 A ...	
		5/8-11	003398	003404	3,000	6,000	5	PNZ 10050 5/8-11 A ...	



PNG type

Made of several very wavy arranged strips of non-woven abrasive material, wound around a core. The wavy structure of the non-woven abrasive material permits seamless brush matting of surfaces.

The tool is designed for working on medium-sized surfaces with speed-adjustable angle grinders and fillet weld grinders, and can be mounted directly onto the drive system's spindle without the need for additional clamping devices.

Abrasive:
Aluminium oxide A

Matching tool drives:
angle grinder, cordless angle grinder

Ordering notes:

■ Please complete the description with the desired grit size.

PFERDVALUE:



D [mm]	T [mm]	Thread	Grit size			Opt. RPM	Max. RPM		Description
			100	180	280				
			EAN 4007220						
100	50	M14	003268	003275	003282	3,000	6,000	5	PNG 10050 M14 A ...
		5/8-11	003299	003305	003312	3,000	6,000	5	PNG 10050 5/8-11 A ...
125	50	M14	002643	002650	002667	2,300	3,800	2	PNG 12550 M14 A ...
		5/8-11	002674	002681	002698	2,300	3,800	2	PNG 12550 5/8-11 A ...



PNL type

The non-woven abrasive flaps are stuck to a glass-fabric backing pad, meaning that the discs can be used face-down. A long tool life is achieved through the dense packing of the flaps.

The tool is designed for working on large surfaces with speed-adjustable angle grinders.

Abrasive:

Aluminium oxide A

Matching tool drives:

angle grinder, cordless angle grinder

Ordering notes:

■ Please complete the description with the desired grit size.

PFERDVALUE:



D [mm]	T [mm]	H [mm]	Grit size			Opt. RPM	Max. RPM	📦	Description
			100	180	280				
			EAN 4007220						
115	20	22.23	104224	104231	104248	2,500	5,300	5	PNL 115-22,23 A ...
125	20	22.23	104286	104293	104309	2,300	4,850	5	PNL 125-22,23 A ...

PNZ type

The non-woven and abrasive-cloth flaps are stuck to a glass-fabric backing pad, meaning that the discs can be used face-down on large surfaces. A long tool life is achieved through the dense packing of the flaps.

The tool is designed for working on large surfaces with speed-adjustable angle grinders.

Abrasive:

Aluminium oxide A

Matching tool drives:

angle grinder, cordless angle grinder

Ordering notes:

■ Please complete the description with the desired grit size.

PFERDVALUE:



D [mm]	T [mm]	H [mm]	Grit size		Opt. RPM	Max. RPM	📦	Description
			100	180				
			EAN 4007220					
115	20	22.23	104316	104323	2,500	5,300	5	PNZ 115-22,23 A ...
125	20	22.23	104330	104347	2,300	4,850	5	PNZ 125-22,23 A ...



Non-woven tools

General information – POLINOX grinding drums

POLINOX grinding drums are especially suited to work on flat surfaces.

Advantages:

- Long tool life due to tightly packed flaps.
- Cool grinding and low thermal load of the workpiece.
- No tool clogging due to open structure and high flexibility of the non-woven material.

Materials that can be worked:

- Can be used on nearly all materials.

Applications:

- Roughening
- Deburring
- Surface work
- Cleaning
- Structuring (matt finishing, brush matting and satin finishing)
- Step-by-step fine grinding

Matching tool drives:

- Drum grinders

Ordering notes:

- The 19 mm centre hole diameter with 4 keyways fits all conventional drum grinders.
- Additional drum tools can be found on pages 90, 134 as well as in catalogue section 8.
- When ordering, please state the EAN or the full description.
- **Ordering example:**
EAN 4007220593523
PNL-W 100100 A 100
- **Ordering example explanation:**
PNL-W = POLINOX grinding drums
100100 = Outer diameter D x width T [mm]
A = Abrasive
100 = Grit size

Safety notes:

- For safety reasons, the specified maximum permitted rotational speed must never be exceeded.



PFERDVALUE:

PFERDERGONOMICS recommends POLINOX grinding drums to sustainably reduce vibration and noise levels during use and to improve working comfort.



POLINOX grinding drums

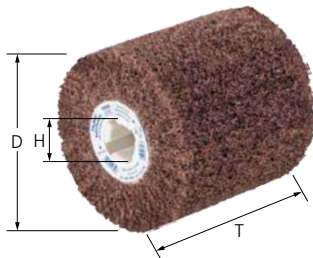

PNL-W type

Made of radially arranged flaps of non-woven abrasive material. A long tool life is achieved through the dense packing of the flaps.

Abrasive:

Aluminium oxide A

Ordering notes:

- Please complete the description with the desired grit size.

PFERDVALUE:



D [mm]	T [mm]	H [mm]	Grit size				Opt. RPM	Max. RPM		Description
			80	100	180	280				
EAN 4007220										
100	100	19	855904	593523	593530	593547	2,500	4,800	1	PNL-W 100100 A ...



PNZ-W type

Made of radially arranged flaps of non-woven abrasive material. There is also abrasive cloth situated between the flaps. The flap structure facilitates improved stock removal and achieves a coarser surface finish.

Abrasive:
Aluminium oxide A

PFERDVALUE:



Ordering notes:

■ Please complete the description with the desired grit size.

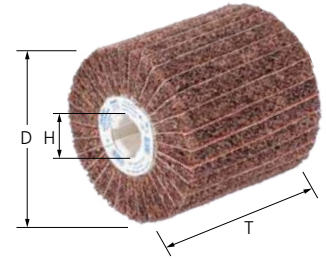

D [mm]	T [mm]	H [mm]	Grit size			Opt. RPM	Max. RPM	Description
			60	80	120			
			EAN 4007220					
100	100	19	593554	593561	593578	2,500	4,800	1 PNZ-W 100100 A ...

PNG-W type

Made of several very wavy arranged strips of non-woven abrasive material, wound around a core. The wavy structure of the non-woven abrasive material permits seamless brush matting of large surfaces.

Abrasive:
Aluminium oxide A

PFERDVALUE:



Ordering notes:

■ Please complete the description with the desired grit size.



D [mm]	T [mm]	H [mm]	Grit size			Opt. RPM	Max. RPM	Description
			100	180	280			
			EAN 4007220					
100	100	19	002612	002629	002636	2,500	4,800	1 PNG-W 100100 A ...



Non-woven tools

General information – POLINOX discs

POLINOX discs are suited to flexible work on complicated tool contours, and are used in peripheral grinding applications.

Advantages:

- Optimum adaptation to contours thanks to high flexibility with a very long tool life.
- Accessing hard-to-reach places such as deep slots or recesses.
- No tool clogging due to open structure and high flexibility of the non-woven material.

Materials that can be worked:

- Can be used on nearly all materials.

Applications:

- Roughening
- Levelling
- Surface work
- Cleaning
- Removing heat discolouration
- Removing paint
- Derusting
- Removing oxide layers
- Work on weld seams
- Structuring (matt finishing, brush matting and satin finishing)
- Step-by-step fine grinding

Matching tool drives:

- Flexible shaft drives
- Straight grinders

Ordering notes:

- Please order arbors separately.
- When ordering, please state the EAN or the full description.
- **Ordering example:**
EAN 4007220**505847**
PVR 15008-13 A **100**
- **Ordering example explanation:**
PVR = POLINOX discs
15008 = Outer diameter D x width T [mm]
13 = Centre hole diameter H [mm]
A = Abrasive
100 = Grit size

Accessories:

- Arbors for POLINOX discs

Safety notes:

- For safety reasons, the specified maximum permitted rotational speed must never be exceeded.



PFERDVALUE:

PFERDERGONOMICS recommends POLINOX discs to sustainably reduce vibration and noise levels during use and to improve working comfort.

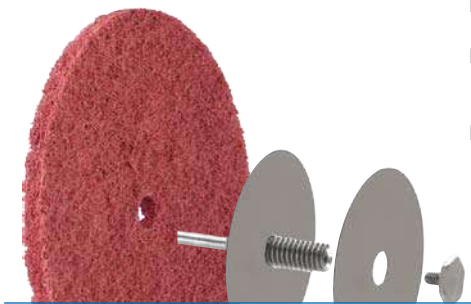

POLINOX discs

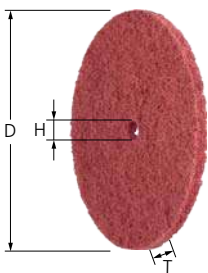

PVR

POLINOX discs are suited to flexible work on complicated tool contours, and are used in peripheral grinding applications.

Abrasive:

Aluminium oxide A

Recommendations for use:

- Clamp up to three discs behind one another to increase the usage width.
- For the best results, use at a recommended cutting speed of 10–25 m/s.

Ordering notes:

- Please order the matching arbor separately.
- Please complete the description with the desired grit size.

PFERDVALUE:



D [mm]	T [mm]	H [mm]	Grit size		Opt. RPM	Max. RPM	Suitable arbors		Description
			100	280					
			EAN 4007220						
50	10	6	955796	955802	3,500–9,500	12,250	BO 6/6 3-10	10	PVR 5008-6 A ...
75	10	6	955819	955826	2,500–6,400	8,150	BO 6/6 3-10	10	PVR 7508-6 A ...
100	10	13	955833	955840	1,900–4,700	6,150	PVR 6/13 1-25	10	PVR 10008-13 A ...
125	10	13	955857	955864	1,500–3,800	4,900	PVR 6/13 1-25	10	PVR 12508-13 A ...
150	10	13	505847	505861	1,300–3,100	4,100	PVR 6/13 1-25	10	PVR 15008-13 A ...

PVR

Arbors for POLINOX discs.

Advantages:

- High economic efficiency as the tool can be changed quickly.

Recommendations for use:

- Preset the clamping depth via the hexagonal nut on the shank side of the arbor.
- Use the supplied side discs with a diameter of 50 and 80 mm in order to vary the lateral flexibility.
- To simplify the changeover, slacken the mounting screw on the front. When doing so, leave the arbor clamped in the tool drive.

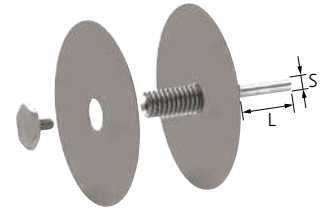

Suitable for centre hole dia. [mm]	S [mm]	L [mm]	Clamping width [mm]	EAN 4007220		Description
13	6	35	1-25	505878	1	PVR 6/13 1-25

ADB masking tape

ADB

The self-adhesive masking tape is used to preserve the clear separation between different grinding patterns in adjacent areas. The masking tape protects surfaces which have already been worked on, or which are not supposed to be worked on.

Advantages:

- ADB 20: High elasticity and tear strength.
- ADB 50 INOX: Reusable and extremely high durability.
- High edge stability.

Recommendations for use:

- ADB 20: Use only during finish machining with soft, flexible tools, e.g. non-woven tools.
- To avoid its inadvertent removal, ensure that the masking tape is only loaded in the running direction of the tool.



Materials that can be worked:
 aluminium, stainless steel (INOX)

L [m]	T [mm]	EAN 4007220		Description
25	20	726372	1	ADB 20
3	50	025352	1	ADB 50 INOX



Non-woven tools

POLINOX marbling tools

POLINOX discs for marbling tool holders are special tools designed for marbling surfaces.

Advantages:

- Water- and oil-tight.

Materials that can be worked:

- Can be used on nearly all materials.

Matching tool drives:

- Flexible shaft drives
- Power drills
- Column drills
- Straight grinders

Ordering notes:

- Please order marbling tool holders separately.
- **Ordering example:**
EAN 4007220156964
MKRK 40 A 100
- **Ordering example explanation:**
MKRK = Marbling discs
40 = Outer diameter D_1 [mm]
A = Abrasive
100 = Grit size

Safety notes:

- For safety reasons, the specified maximum permitted rotational speed must never be exceeded.



PFERDVALUE:

PFERDERGONOMICS recommends POLINOX discs for marbling tool holders to sustainably reduce vibration and noise levels during use and to improve working comfort.

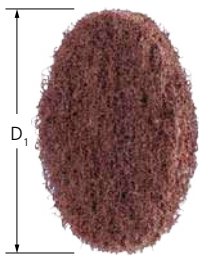

POLINOX discs for marbling tool holder MKRK

Special tools for marbling surfaces.

Advantages:

- Highly flexible, enabling optimal adjustment to the contour.
- High economic efficiency due to high abrasive performance and tool life.
- The open structure and high flexibility of the non-woven material prevents tool clogging.

Abrasive:

Aluminium oxide A

Recommendations for use:

- POLINOX discs for marbling tool holders must be used with the matching marbling tool holder.

Ordering notes:

- Please order marbling tool holders separately.
- Please complete the description with the desired grit size.

PFERDVALUE:



D_1 [mm]	Grit size			Opt. RPM	Suitable arbors		Description
	100	180	280				
	EAN 4007220						
40	156964	156971	156988	600–1,400	MK 6/40/6	100	MKRK 40 A ...
50	156995	157008	157015	600–1,400	MK 6/50/6	100	MKRK 50 A ...
60	157022	157039	157046	600–1,400	MK 6/60/6	100	MKRK 60 A ...

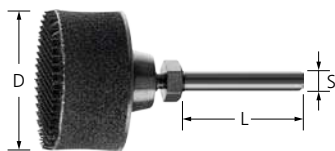

POLINOX marbling tool holders MK

POLINOX marbling tool holders for marbling discs. A highly elastic intermediate layer carries the Velcro fastening system.

Advantages:

- Highly flexible, enabling optimal adjustment to the contour.
- High economic efficiency due to high abrasive performance and tool life.

D [mm]	S [mm]	L [mm]	Suitable tool	EAN 4007220	Max. RPM		Description
40	6	40	MKRK 40	156933	4,700	1	MK 6/40/6
50	6	40	MKRK 50	156940	3,800	1	MK 6/50/6
60	6	40	MKRK 60	156957	3,200	1	MK 6/60/6

PFERD supplies POLIVLIES flap discs and self-adhesive discs in various grit sizes, diameters and types. These are particularly suited to work on large surfaces made from stainless steel (INOX).

Advantages:

- High profitability thanks to high abrasive performance and long tool life.
- Creates a consistently high surface quality throughout the entire tool life as new, sharp abrasive material is constantly freed up.
- Optimum adaptation to contours thanks to high flexibility.

Materials that can be worked:

- Can be used on nearly all materials.

Matching tool drives:

- Angle grinders
- Cordless angle grinders

Ordering notes:

- When ordering, please state the EAN or the full description. Please complete the description with the desired grit size.
- **Ordering example:**
EAN 4007220748343
PVL 115 A **180 M**
- **Ordering example explanation:**
PVL = POLIVLIES flap discs
115 = Outer diameter D [mm]
A = Abrasive
180 M = Grit size

Safety notes:

- For safety reasons, the specified maximum permitted rotational speed must never be exceeded.



Flap discs PVL

For universal coarse to fine grinding applications in industry and professional trades.

Abrasive:

Aluminium oxide A
Available POLIVLIES grit sizes:
100 G = coarse (yellow-brown)
180 M = medium (red-brown)
240 F = fine (blue)

Recommendations for use:

- For the best results, use at a recommended cutting speed of 30–35 m/s.

Ordering notes:

- Please complete the description with the desired grit size.



D [mm]	T [mm]	H [mm]	Grit size			Opt. RPM	Max. RPM		Description
			100 G	180 M	240 F				
EAN 4007220									
115	18	22.23	748336	748343	748350	5,000–5,800	13,300	5	PVL 115 A ...
125	18	22.23	748367	748374	748381	4,600–5,300	12,200	5	PVL 125 A ...

Flap discs PVZ

For aggressive grinding with maximum stock removal rate on hard materials which do not conduct heat well. Consistently high performance due to self-sharpening ceramic oxide grain. Active grinding additives in the coating substantially improve the stock removal rate, prevent clogging and result in cooler grinding.

Abrasive:

Abrasive flap: Ceramic oxide grain CO-COOL
Non-woven material: Aluminium oxide A
Available POLIVLIES grit sizes:
100 G = coarse (yellow-brown)
180 M = medium (red-brown)
240 F = fine (blue)

Recommendations for use:

- For the best results, use at a recommended cutting speed of 30–35 m/s.

Ordering notes:

- Please complete the description with the desired grit size.



D [mm]	T [mm]	H [mm]	Grit size			Opt. RPM	Max. RPM		Description
			CO-COOL 60 / A 100 G	CO-COOL 80 / A 180 M	CO-COOL 120 / A 240 F				
EAN 4007220									
115	18	22.23	106334	106341	106358	5,000–5,800	13,300	5	PVZ 115 CO-COOL ...
125	18	22.23	106365	106372	106389	4,600–5,300	12,200	5	PVZ 125 CO-COOL ...

Non-woven tools

POLIVLIES grinding discs



Self-adhesive discs PVKR

POLIVLIES self-adhesive discs are suited to grinding larger surfaces. The flexible system comprising a POLIVLIES self-adhesive disc and the associated POLIVLIES self-adhesive disc holder enables use on contours. The pre-punched holes mean that they can be ideally centred on and used with various backing pads.

Abrasive:

Aluminium oxide A
 Available POLIVLIES grit sizes:
 100 G = coarse (yellow-brown)
 180 M = medium (red-brown)
 240 F = fine (blue)

Ordering notes:

- Please order POLIVLIES self-adhesive disc holders separately.
- Please complete the description with the desired grit size.

Recommendations for use:

- For the best results, use at a recommended cutting speed of 15–20 m/s.
- Use with POLIVLIES self-adhesive disc holder.
- Break out the pre-punched centring hole if required.

D ₁ [mm]	Grit size			Opt. RPM	Max. RPM	Suitable arbors		Description
	100 G	180 M	240 F					
	EAN 4007220							
115	354230	297469	354254	3,300	5,300	PVKRH 115	10	PVKR 115 A ...
125	354261	297452	354278	3,000	4,850	PVKRH 125	10	PVKR 125 A ...
180	354285	354292	354308	2,200	3,500	PVKRH 180	10	PVKR 180 A ...

Self-adhesive disc holders PVKRH



Self-adhesive disc holders PVKRH

Arbors for POLIVLIES self-adhesive discs.

Advantages:

- High economic efficiency as the tool can be changed quickly.
- Enables surface finishing without visible transitions.
- PVKRH-22: Enables faster central clamping.

D [mm]	Thread	EAN 4007220	Max. RPM		Description
Without centring pin					
115	M14	316962	5,300	1	PVKRH 115 M14
125	M14	316979	4,850	1	PVKRH 125 M14
180	M14	354223	3,500	1	PVKRH 180 M14
With centring pin					
115	M14	095713	5,300	1	PVKRH 115-22 M14
125	M14	095775	4,850	1	PVKRH 125-22 M14
180	M14	095782	3,500	1	PVKRH 180-22 M14



POLICLEAN is a coarsely structured, abrasive, non-woven cleaning fabric that was developed from a special combination of synthetic fibres and abrasive grain.

The comprehensive range of POLICLEAN tools contains:

- POLICLEAN wheels
- POLICLEAN mounted tools
- COMBIDISC POLICLEAN discs (see COMBIDISC tools, page 38)
- POLICLEAN discs

Advantages:

- High flexibility and open structure mean ideal adaptation to contours and no clogging of the tool itself.
- The standard type (black) achieves finer surface finishes and is more flexible.
- The PLUS type (blue) exhibits considerably higher stock removal rates with a very long tool life, and is also very aggressive.

Materials that can be worked:

- Can be used on nearly all materials.

Applications:

- Roughening
- Surface work
- Cleaning
- Removing heat discolouration
- Removing paint
- Derusting
- Descaling
- Removing oxide layers

Abrasive:

- Standard (black) = Silicon carbide SiC
- PLUS (blue) = Aluminium oxide A

Recommendations for use:

- For best performance, use with a recommended cutting speed of 15–20 m/s. This provides an ideal compromise between stock removal rate, surface quality, thermal load on the workpiece and tool wear.

Ordering notes:

- When ordering, please state the EAN or the full description.
- **Ordering example:**
EAN 4007220471470
PCLS 7513/6
- **Ordering example explanation:**
PCLS = POLICLEAN wheels
75 = Outer diameter D [mm]
13 = Width T [mm]
6 = Centre hole diameter H [mm]

Safety notes:

- For safety reasons, the specified maximum permitted rotational speed must never be exceeded.

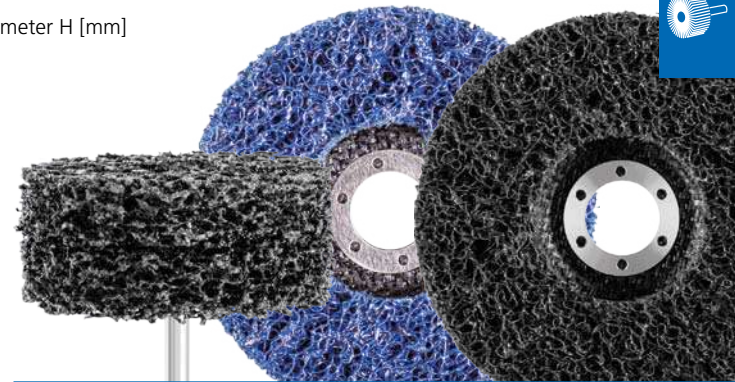

Recommended rotational speed range

Example:

PCLS 7513/6

Cutting speed: 15–20 m/s

Rotational speed: 3,800–5,000 RPM

Tool dia. [mm]	Cutting speed [m/s]				
	10	15	20	30	40
	Rotational speeds [RPM]				
75	2,500	3,800	5,000	7,600	10,100
100	1,900	2,800	3,800	5,700	7,600
115	1,600	2,400	3,300	4,900	6,600
125	1,500	2,200	3,000	4,500	6,100
150	1,200	1,900	2,500	3,800	5,000



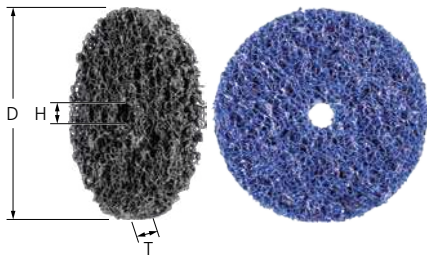

POLICLEAN wheels PCLS, POLICLEAN wheels PCLS PLUS

For coarse cleaning work such as removing paint, scale, heat discoloration, rust and adhesive residues in peripheral grinding.

POLICLEAN PLUS discs exhibit a higher stock removal rate with a very long tool life.

Recommendations for use:

- For work on larger surfaces, pack several POLICLEAN wheels with the appropriate arbor.

Matching tool drives:

flexible shaft drive, power drill, straight grinder

Ordering notes:

- Please order the matching arbor separately.

D [mm]	T [mm]	H [mm]	EAN 4007220	Opt. RPM	Max. RPM	Suitable arbors	Description
PCLS type (black)							
75	13	6	471470	4,000–5,100	10,000	PCLB 6/6/13, PCLB 6/6/26, PCLB 6/6/39	6 PCLS 7513/6
100	13	13	471487	3,000–3,800	7,500	PCLB 6/13/13, PCLB 6/13/26, PCLB 8/13/13, PCLB 8/13/26	4 PCLS 10013/13
150	13	13	471494	2,000–2,500	5,100	PCLB 6/13/13, PCLB 6/13/26, PCLB 8/13/13, PCLB 8/13/26	4 PCLS 15013/13
PCLS PLUS type (blue)							
75	13	6	069257	4,000–5,100	10,000	PCLB 6/6/13, PCLB 6/6/26, PCLB 6/6/39	6 PCLS PLUS 7513/6
100	13	13	069264	3,000–3,800	7,500	PCLB 6/13/13, PCLB 6/13/26, PCLB 8/13/13, PCLB 8/13/26	4 PCLS PLUS 10013/13
150	13	13	069271	2,000–2,500	5,100	PCLB 6/13/13, PCLB 6/13/26, PCLB 8/13/13, PCLB 8/13/26	4 PCLS PLUS 15013/13

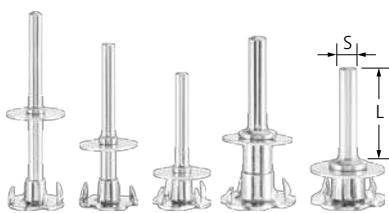

POLICLEAN arbors PCLB

Arbors for POLICLEAN wheels. The different variants provide space for 1, 2 or 3 wheels.

Advantages:

- High economic efficiency as the tool can be changed quickly.

Recommendations for use:

- When replacing the wheels, leave the arbor clamped in the tool drive.

Suitable for centre hole dia. [mm]	S [mm]	L [mm]	Suitable tool	EAN 4007220	Packaging	Description
6	6	40	PCLS 7513/6	471562	1 wheel	PCLB 6/6/13
				471579	2 wheels	PCLB 6/6/26
				471586	3 wheels	PCLB 6/6/39
13	6	40	PCLS 10013/13, PCLS 15013/13	532928	1 wheel	PCLB 6/13/13
				532935	2 wheels	PCLB 6/13/26
				471593	1 wheel	PCLB 8/13/13
				471609	2 wheels	PCLB 8/13/26

**POLICLEAN mounted tools PCLZY,
POLICLEAN mounted tools PCLZY PLUS**

For coarse cleaning work such as removing paint, scale, heat discolouration, rust and adhesive residues in peripheral grinding.



Matching tool drives:
flexible shaft drive, power drill, straight grinder

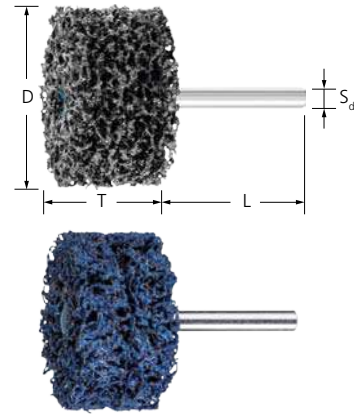

D [mm]	T [mm]	S _d [mm]	L [mm]	EAN 4007220	Opt. RPM	Max. RPM		Description
PCLZY type (black)								
50	13	6	40	661321	6,000–7,000	15,000	5	PCLZY 5013/6
	26	6	40	661369	6,000–7,000	15,000	5	PCLZY 5026/6
75	13	6	40	661376	4,000–5,100	10,000	5	PCLZY 7513/6
	26	6	40	661383	4,000–5,100	10,000	5	PCLZY 7526/6
100	13	6	40	661406	3,000–3,800	7,500	5	PCLZY 10013/6
PCLZY PLUS type (blue)								
50	13	6	40	098547	6,000–7,000	15,000	5	PCLZY PLUS 5013/6
	26	6	40	098639	6,000–7,000	15,000	5	PCLZY PLUS 5026/6
75	13	6	40	098905	4,000–5,100	10,000	5	PCLZY PLUS 7513/6
	26	6	40	101025	4,000–5,100	10,000	5	PCLZY PLUS 7526/6
100	13	6	40	101032	3,000–3,800	7,500	5	PCLZY PLUS 10013/6



POLICLEAN discs PCLD, POLICLEAN discs PCLD PLUS

The non-woven cleaning material is glued onto a glass-fabric base. This makes POLICLEAN discs suitable for use in face-down grinding.

For coarse cleaning work such as removing paint, scale, heat discolouration, rust and adhesive residues.

POLICLEAN PLUS DISCS exhibit a high stock removal rate with a very long tool life.



Recommendations for use:

- Preferably for use on slow-running angle grinders.
- For the best results, use at a recommended cutting speed of 30–35 m/s.

Matching tool drives:
angle grinder, cordless angle grinder



D [mm]	T [mm]	H [mm]	EAN 4007220	Opt. RPM	Max. RPM		Description
PCLD type (black)							
115	13	22.23	515280	5,000–7,000	10,000	5	PCLD 115-13
125	13	22.23	515297	5,000–7,000	10,000	5	PCLD 125-13
PCLD PLUS type (blue)							
100	13	16	069202	5,000–7,000	10,000	5	PCLD PLUS 100-13
115	13	22.23	069233	5,000–7,000	10,000	5	PCLD PLUS 115-13
125	13	22.23	069240	5,000–7,000	10,000	5	PCLD PLUS 125-13

Poliflex fine grinding tools are manufactured with high shape accuracy, outstandingly consistent quality and tight dimensional tolerances.

They are ideally suited to fine grinding, structuring and preparations for polishing work, and are very frequently used for tool- and mould-making applications.

Advantages:

- For achieving very good surface quality standards.
- High profitability thanks to long tool life and high stock removal rate.
- Outstanding working comfort thanks to precise concentricity.

Applications:

- Structuring (matt finishing, brush matting and satin finishing)
- Step-by-step fine grinding

Recommendations for use:

- Depending on the application, profile with a diamond dresser or with ceramic dressing stones at a low rotational speed. Please refer to catalogue section 3 for detailed information and ordering data for dressing tools.

Explanation of the code system according to EN 12413:

- D = Grinding point outer diameter
- T = Grinding point width
- S_d = Shank diameter
- L₀ = Unsupported shank length
- L₂ = Shank length
- L₃ = Clamping length of shank

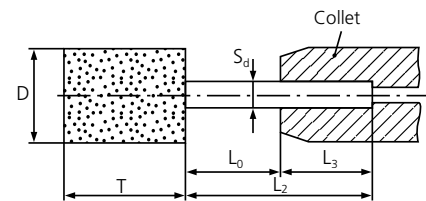

Recommended rotational speed range

Example:

PF KU 15/6 AR 120 GR

Tool dia.: 15 mm

Cutting speed: 15 m/s

Rotational speed: 19,000 RPM

Tool dia. [mm]	Cutting speed [m/s]						
	10	12	15	20	25	30	50
	Rotational speeds [RPM]						
4	47,700	57,200	71,600	95,400	119,300	143,200	238,700
6	31,800	38,100	47,700	63,600	79,500	95,400	159,100
8	23,800	28,600	35,800	47,700	59,600	71,600	119,300
10	19,000	22,900	28,600	38,100	47,700	57,200	95,400
12	15,900	19,000	23,800	31,800	39,700	47,700	79,500
15	12,700	15,200	19,000	25,400	31,800	38,100	63,600
20	9,500	11,400	14,300	19,000	23,800	28,600	47,700
25	7,600	9,100	11,400	15,200	19,000	22,900	38,100
30	6,300	7,600	9,500	12,700	15,900	19,000	31,800
32	5,900	7,100	8,900	11,900	14,900	17,900	29,800
40	4,700	5,700	7,100	9,500	11,900	14,300	23,800
50	3,800	4,500	5,700	7,600	9,500	11,400	19,000
60	3,100	3,800	4,700	6,300	7,900	9,500	15,900
75	2,500	3,000	3,800	5,000	6,300	7,600	12,700
100	1,900	2,200	2,800	3,800	4,700	5,700	9,500
125	1,500	1,800	2,200	3,000	3,800	4,500	7,600
150	1,200	1,500	1,900	2,500	3,100	3,800	6,300



PF ZY 2030 6 AR 120 GR

① ② ③ ④ ⑤ ⑥ ⑦

① Product code

PF = Abbreviation of Poliflex

② Shapes

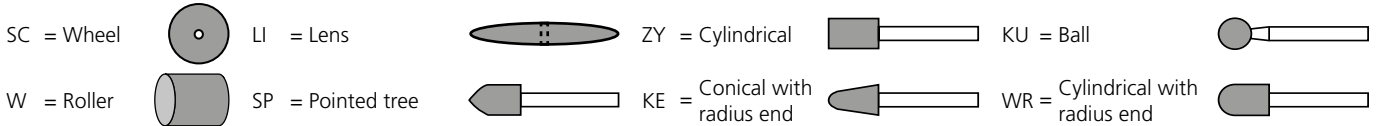

③ Dimensions

Grinding point outer diameter D x grinding point width T [mm]
20 mm x 30 mm = 2030

④ Mounting options

Poliflex fine grinding points

Shank diameter S_d x shank length L_2 [mm]
3 mm x 30 mm
6 mm x 40 mm
8 mm x 40 mm

Poliflex fine grinding wheels

Depending on the respective wheel dimension, the centre hole diameters are either 2, 3, 6, 10 or 20 mm.

Poliflex marbling tools

Female thread M8

⑤ Abrasive

In general, two grain types are used, with internationally defined designations according to ISO 525:
A = Aluminium oxide (Al_2O_3) C = Silicon carbide (SiC)

The following abbreviations are used in order to specify the grain mixture more precisely, beyond ISO 525:

AW = Aluminium oxide, white	CN = Silicon carbide, green	ANCN = Mixture of AN + CN
AR = Aluminium oxide, pink	CU = Silicon carbide, grey	
AN = Aluminium oxide, standard	AWCN = Mixture of AW + CN	

⑥ Grit sizes according to ISO 525 and ISO 8486

The grit sizes used in PFERD fine grinding points are determined by the shape and diameter of the fine grinding point.

⑦ Bond

The following bonds are available:

PUR = Polyurethane (soft, medium-hard)	PU-STRUC = Polyurethane	TX = Textile
GR = Rubber	GHR = Rubber, hard	
LR = Leather	LHR = Leather, hard	

Safety notes:

The following maximum operating speeds are permitted for Poliflex fine grinding tools:

PUR	15 m/s	The maximum rotational speeds for the various shank lengths and shank diameters are defined in DIN 69170 based on EN 12413. These must be adhered to in order to avoid buckling of the shank during use.
GR	15 m/s	
LR	30 m/s	Regardless of the shank length, the clamping length (L_2) of the shank must be at least 10 mm.
TX	30 m/s	
PUR-STRUC	15 m/s	The maximum permitted rotational speed calculated according to EN 12413 is determined by the following factors: ■ Shape and dimensions of the grinding point ■ Diameter of the steel shank S_d ■ Unsupported shank length L_0
GHR	30 m/s	
LHR	50 m/s	

Each packaging unit of PFERD fine grinding points comes with rotational speed specifications for the unsupported shank length (L_0) of that wheel. Proper concentric accuracy and correct clamping of the tool drive must also be ensured.

Tables with the maximum permitted rotational speeds for the entire range of Poliflex fine grinding points are available on request.



To make it easier to choose the right Poliflex fine grinding tool, we have designed our range around material groups, main areas of application and special operational requirements.

The overview shows which variations of abrasives and bonds are recommended for the various materials with a view to the tasks at hand.

The differentiation of the selection criteria in terms of material, application and surface finish are necessary to find the best tool. The tool bond and grain mixture have a decisive impact on the abrasive performance, tool life and aggressiveness of the tools. What's more, they also determine the look of the surface.

How do you find the best Poliflex fine grinding tool?

1 Material

The material of the component to be machined is generally known in advance. The various material groups are colour-coded and form the starting point for choosing the most appropriate fine grinding tool.

1 Material group ▼			2 Application ▼		Bond ▶	
					Abrasive (grain mixtures) ▶	
					4 Designation/bond ▶	
					Recommended cutting speed ▶	
					3 Surface finish ▼	
Steel, cast steel	Steels up to 1,200 N/mm ² (< 38 HRC)	Construction steels, carbon steels, tool steels, non-alloyed steels, case-hardened steels, tempering steels, cast steel	Surface grinding	Matt surface		
			Shiny surface			
	Hardened, heat-treated steels over 1,200 N/mm ² (> 38 HRC)	Tool steels, tempering steels, alloyed steels, alloyed cast steel	Edge grinding with high dimensional stability	Matt surface		
			Shiny surface			
Stainless steel (INOX)	Rust- and acid-resistant steels	Austenitic and ferritic stainless steels	Surface grinding	Matt surface		
			Shiny surface			
			Edge grinding with high dimensional stability	Matt surface		
			Shiny surface			
Non-ferrous metals	Soft non-ferrous metals, non-ferrous metals	Aluminium alloys, brass, copper, zinc	General use	Structured surface		
			Surface grinding	Matt surface		
			Shiny surface			
	Hard non-ferrous metals	Bronze, titanium, titanium alloys, hard aluminium alloys (high Si content)	Edge grinding with high dimensional stability	Matt surface		
				Shiny surface		
				Surface grinding	Matt surface	
			Shiny surface			
			High-temperature-resistant materials	Nickel-based and cobalt-based alloys (engine and turbine construction)	Edge grinding with high dimensional stability	Matt surface
						Shiny surface
Surface grinding	Matt surface					
Shiny surface						

● = Highly suitable

○ = Suitable

5 Catalogue page ▶

2 Application

After the material, the application must be selected:

- General use
 Surface grinding
 Edge grinding

3 Desired surface finish

Next, the desired work result must be selected:









- Matt surface
 Shiny surface
 Structured surface

4 Tool bond

After determining the application and the desired surface finish, the appropriate bond can be selected from the options in the right-hand side of the overview. The "highly suitable" bond is indicated by a solid black dot (●). Further "suitable" bonds are indicated by an open dot (○).

5 Reference to catalogue page

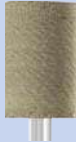
Further information about the selected bond, tool shapes and dimensions, and grit sizes can be found on the corresponding catalogue pages stated in the table.

Polyurethane bond			Elastomer bond				Resinoid bond
CN			AR	ANCN	AW	AWCN	AN
							
W (soft)	PUR MH (medium-hard)	STRUC	GR	GHR	LR	LHR	TX
10–12 m/s	10–15 m/s	5–10 m/s	10–12 m/s	20–25 m/s	15–20 m/s	30–40 m/s	20–25 m/s
○	●		○				
			●		○		
	○		○				●
				●		○	
○	●		○				
			○		●		
	○						●
				○		●	
●	○						
			●		○		
	○						●
				●	○		
○	○	●					
●	○						○
			○		●		
				○			●
			○		●		
	○						●
			○	●			
				○			●
				○		●	
	○						●
			●	○			
	○			○			●
				○		●	
130–131	130–131	133–134	135–137	135–137	138–139	138–139	140–142



Poliflex fine grinding tools with the PUR bond are manufactured with green silicon carbide (SiC). The PUR bond is a very soft bond which is available in two hardness grades (PUR-W, PUR-MH). It is homogeneously interspersed with abrasive grain.

Advantages:

- Optimum adaptation to contours thanks to high flexibility.
- Cool, very soft grinding thanks to open structure and elastic bond.
- For achieving a fine, matt surface finish.

Abrasive:

- Silicon carbide SiC

Recommendations for use:

- Depending on the application, profile with a diamond dresser or with ceramic dressing stones at a low rotational speed. Please refer to catalogue section 3 for detailed information and ordering data for dressing tools.
- For best performance, use with a recommended cutting speed of 10–15 m/s.

Ordering notes:

- When ordering, please state the EAN or the full description.

Safety notes:

- For safety reasons, the specified maximum permitted rotational speed must never be exceeded.
- The clamping length of the shank must be at least 10 mm.

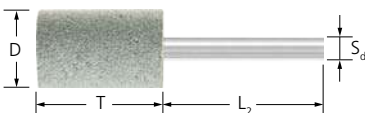

Poliflex fine grinding points PF ZY PUR

Fine grinding point in cylindrical shape, for fine grinding of small surfaces.



Matching tool drives:

flexible shaft drive, straight grinder

Ordering notes:

- Please complete the description with the desired grit size.

D [mm]	T [mm]	S _d [mm]	L ₂ [mm]	Grit size			Opt. RPM	Max. RPM		Description
				80	150	220				
				EAN 4007220						
Shank dia. 3 mm PUR-W										
8	12	3	30	535004	535028	-	24,000	35,800	10	PF ZY 0812/3 CN ... PUR-W
Shank dia. 6 mm PUR-W										
10	25	6	40	535042	535073	-	19,000	28,600	10	PF ZY 1025/6 CN ... PUR-W
15	30	6	40	535141	535165	-	12,500	19,000	10	PF ZY 1530/6 CN ... PUR-W
20	30	6	40	535233	535257	-	9,500	14,300	10	PF ZY 2030/6 CN ... PUR-W
25	30	6	40	297841	297865	-	7,500	11,400	10	PF ZY 2530/6 CN ... PUR-W
Shank dia. 3 mm PUR-MH										
8	12	3	30	-	535011	535035	24,000	35,800	10	PF ZY 0812/3 CN ... PUR-MH
Shank diameter of 6 mm PUR-MH										
10	25	6	40	-	535059	535080	19,000	28,600	10	PF ZY 1025/6 CN ... PUR-MH
15	30	6	40	535134	535158	535172	12,500	19,000	10	PF ZY 1530/6 CN ... PUR-MH
20	30	6	40	535325	535240	-	9,500	14,300	10	PF ZY 2030/6 CN ... PUR-MH
32	32	6	40	535288	535295	-	6,000	8,900	5	PF ZY 3232/6 CN ... PUR-MH

Poliflex discs PFD PUR

For fine face-down grinding on large surfaces.

Recommendations for use:

- Preferably for use on slow-running angle grinders.

Ordering notes:

- Please complete the description with the desired grit size.



Matching tool drives:

angle grinder, cordless angle grinder

D [mm]	T [mm]	H [mm]	Type	Grit size		Opt. RPM	Max. RPM		Description
				60	150				
				EAN 4007220					
115	14	22.23	soft	536377	536391	2,400	5,300	5	PFD 115-22 CN ... PUR-W
			medium-hard	536346	536360	2,400	5,300	5	PFD 115-22 CN ... PUR-MH

Poliflex fine grinding wheels PF SC PUR

For fine peripheral grinding of medium-sized to large surfaces.

Matching tool drives:

flexible shaft drive, straight grinder

Ordering notes:

- Please order the matching arbor separately.
- Please complete the description with the desired grit size.

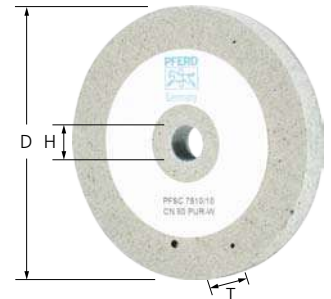

D [mm]	T [mm]	H [mm]	Grit size		Opt. RPM	Max. RPM	Suitable arbors		Description
			80	150					
			EAN 4007220						
75	10	10	144749	-	2,500	3,800	BO 8/10 6-20	5	PF SC 7510/10 CN ... PUR-W
125	20	20	144794	-	1,500	2,300	BO 12/20 10-50, BO MK 1/20 10-50	1	PF SC 12520/20 CN ... PUR-W
150	25	20	298428	298435	1,200	1,900	BO 12/20 10-50, BO MK 1/20 10-50	1	PF SC 15025/20 CN ... PUR-W



Arbors

Arbors BO

Matching arbor for Poliflex fine grinding wheels PF SC.

Advantages:

- High economic efficiency as the tool can be changed quickly.

Matching tool drives:

flexible shaft drive, straight grinder

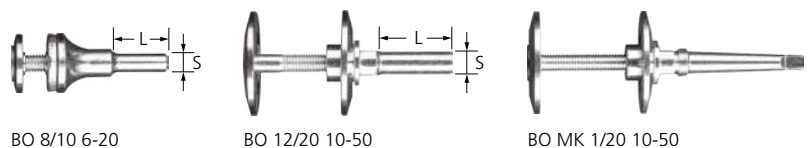

BO 8/10 6-20

BO 12/20 10-50

BO MK 1/20 10-50

Suitable for centre hole dia. [mm]	S [mm]	L [mm]	Clamping width [mm]	EAN 4007220		Description
10	8	30	6-20	297667	1	BO 8/10 6-20
20	12	35	10-50	297674	1	BO 12/20 10-50
	-	-	10-50	297681	1	BO MK 1/20 10-50



Poliflex blocks PUR

The rhomboidal shape even enables work to be effortlessly performed on hard-to-reach places such as corners.

With a diamond cut-off wheel, the blocks can be minimized and adapted to the respective application as required.

Matching tool drives:
manual application

Ordering notes:

■ Please complete the description with the desired grit size.

L [mm]	B [mm]	H [mm]	Grit size				Description
			60	120	240		
			EAN 4007220				
115	60	30	298671	298688	298695	5	PFB 1156030 CU ... PUR



Poliflex block set PSO PUR

Set of different Poliflex blocks PUR.

Contents:

9 units in total, 3 Poliflex blocks from each category

- Grit 60 (coarse)
- Grit 120 (medium)
- Grit 240 (fine)

Advantages:

■ Promotional display box.

Matching tool drives:

manual application

L x B x H [mm]	EAN 4007220		Description
285 x 150 x 60	298886	1	PSO 11560

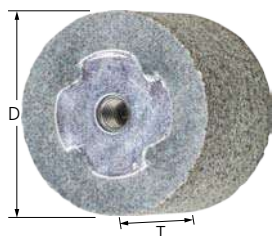

Poliflex marbling tool holders PFZY PUR

Tools with female thread M8 for marbling surfaces.

Recommendations for use:

■ For face-down grinding, use at 1,000–4,000 RPM.

Ordering notes:

- Please order the matching arbor separately.
- Please complete the description with the desired grit size.

Matching tool drives:

flexible shaft drive, straight grinder

D [mm]	T [mm]	Thread	Grit size		Opt. RPM	Max. RPM	Suitable arbors		Description
			30	80					
			EAN 4007220						
50	40	M8	146194	146200	1,000–4,000	5,700	BO 6/8	5	PF ZY 5040 M8 CN ... PUR

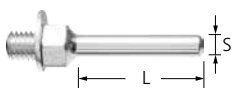

Arbors BO

Matching arbor for Poliflex marbling tool holders PFZY.

Advantages:

■ High economic efficiency as the tool can be changed quickly.

S [mm]	L [mm]	Thread	EAN 4007220		Description
6	40	M8	062104	1	BO 6/8

Poliflex structuring tools with the PU-STRUC bond are manufactured with grey silicon carbide. They are ideally suited to work on components made from stainless steel (INOX). The PU-STRUC bond is homogeneously interspersed with a high proportion of abrasive grain.

Advantages:

- Optimum adaptation to contours thanks to high flexibility.
- Cool, soft grinding thanks to open structure and elastic bond.
- Quick and effective retouching of imperfections and transitions to directional textures.

Abrasive:

- Silicon carbide SiC

Recommendations for use:

- Depending on the application, profile with a diamond dresser or with ceramic dressing stones at a low rotational speed. Please refer to catalogue section 3 for detailed information and ordering data for dressing tools.
- For best performance, use with a recommended cutting speed of 5–10 m/s.

Ordering notes:

- When ordering, please state the EAN or the full description.

Safety notes:

- For safety reasons, the specified maximum permitted rotational speed must never be exceeded.
- The clamping length of the shank must be at least 10 mm.



Poliflex mounted texturing points PF ZY PU-STRUC

Mounted texturing point in cylindrical shape, for structuring small to medium-sized surfaces.

Matching tool drives:

flexible shaft drive, straight grinder

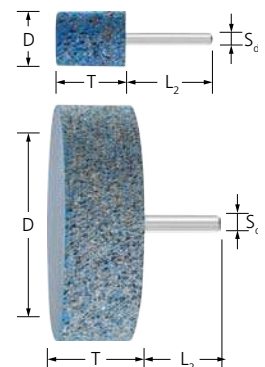

D [mm]	T [mm]	S _d [mm]	L ₂ [mm]	EAN 4007220	Opt. RPM	Max. RPM		Description
Shank dia. 6 mm								
20	30	6	40	752029	4,750–9,550	14,000	10	PF ZY 2030/6 CU 16 PU-STRUC
25	30	6	40	752036	3,800–7,600	11,500	10	PF ZY 2530/6 CU 16 PU-STRUC
32	32	6	40	752043	3,000–6,000	9,000	5	PF ZY 3232/6 CU 16 PU-STRUC
Shank dia. 8 mm								
100	30	8	40	752074	1,000–1,900	2,800	1	PF ZY 10030/8 CU 16 PU-STRUC

Poliflex mounted texturing points PF WR PU-STRUC

Mounted texturing point in cylindrical shape with radius end, for structuring small surfaces, transitions and inner radii.

Matching tool drives:

flexible shaft drive, straight grinder

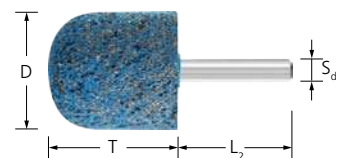

D [mm]	T [mm]	S _d [mm]	L ₂ [mm]	EAN 4007220	Opt. RPM	Max. RPM		Description
30	45	8	40	752081	3,150–6,350	9,500	5	PF WR 3045/8 CU 16 PU-STRUC
40	45	8	40	752104	2,350–4,750	7,000	5	PF WR 4045/8 CU 16 PU-STRUC
50	45	8	40	752111	1,900–3,800	5,700	5	PF WR 5045/8 CU 16 PU-STRUC

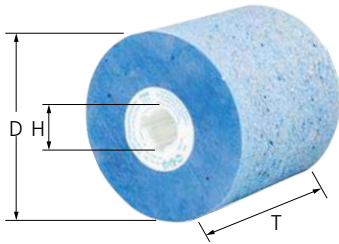

Poliflex texturing rollers PF W PU-STRUC

For structuring large surfaces.

Matching tool drives:
drum grinders

Ordering notes:

- The centre hole diameter of 19 mm with 4 wedge keyways fits on all conventional drum drives.
- Other drum tools can be found in the set on page 90 as well as on pages 116–117 and in catalogue section 8.

D [mm]	T [mm]	H [mm]	Abrasives	EAN 4007220	Opt. RPM	Max. RPM		Description
100	100	19	SiC	752159	1,000–1,900	2,800	1	PF W 100100/19 CU 16 PU-STRUC



Poliflex fine grinding tools with the GR bond are manufactured with pink aluminium oxide. The GR bond is an elastomer-based soft bond. Suitable for use on surfaces.

Poliflex fine grinding tools with the GHR bond are manufactured with an abrasive grain mixture comprising aluminium oxide and silicon carbide (SiC). The GHR bond is likewise a soft yet sturdy elastomer-based bond. Suitable for use on edges.

Advantages:

- For achieving a fine, shiny surface finish.
- **GR:** Soft grinding thanks to soft, elastic bond.
- **GHR:** Soft grinding with a longer tool life.

Abrasive:

- White aluminium oxide AW
- Silicon carbide SiC

Applications:

- Step-by-step fine grinding

Matching tool drives:

- Flexible shaft drives
- Straight grinders

Recommendations for use:

- Depending on the application, profile with a diamond dresser or with ceramic dressing stones at a low rotational speed. Please refer to catalogue section 3 for detailed information and ordering data for dressing tools.
- **GR:** For best performance, use with a recommended cutting speed of 10–12 m/s.
- **GHR:** For best performance, use with a recommended cutting speed of 20–25 m/s.

Ordering notes:

- When ordering, please state the EAN or the full description.

Safety notes:

- For safety reasons, the specified maximum permitted rotational speed must never be exceeded.
- The clamping length of the shank must be at least 10 mm.

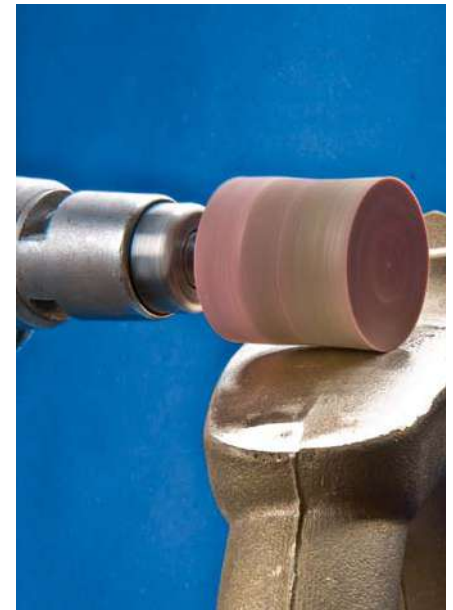

Poliflex fine grinding points PF ZY GR/GHR

Fine grinding points in cylindrical shape, for fine grinding of small surfaces.

Ordering notes:

- Poliflex fine grinding points with a grit size of 400 are manufactured from the abrasive AW white aluminium oxide.
- Please complete the description with the desired grit size.

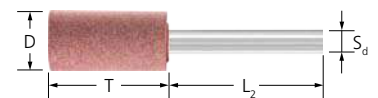

D [mm]	T [mm]	S _d [mm]	L ₂ [mm]	Grit size					Opt. RPM	Max. RPM		Description
				46	80	120	220	400				
EAN 4007220												

Shank dia. 3 mm GR

4	8	3	30	-	-	144800	-	-	47,500	71,600	10	PF ZY 0408/3 AR ... GR
6	10	3	30	-	-	144824	-	-	32,000	47,700	10	PF ZY 0610/3 AR ... GR
8	8	3	30	-	-	144848	144855	-	24,000	35,800	10	PF ZY 0808/3 AR ... GR
	12	3	30	-	-	144886	144893	-	24,000	35,800	10	PF ZY 0812/3 AR ... GR
10	6	3	30	-	-	145838	-	-	19,000	28,600	10	PF ZY 1006/3 AR ... GR
	10	3	30	-	-	144947	144954	-	19,000	28,600	10	PF ZY 1010/3 AR ... GR
	15	3	30	-	-	145036	145043	-	19,000	28,600	10	PF ZY 1015/3 AR ... GR
12	8	3	30	-	-	145883	-	-	16,000	23,800	10	PF ZY 1208/3 AR ... GR
	12	3	30	-	-	145203	-	-	16,000	23,800	10	PF ZY 1212/3 AR ... GR
	20	3	30	-	-	145265	-	-	16,000	23,800	10	PF ZY 1220/3 AR ... GR

Shank diameter of 6 mm GR

10	10	6	40	-	-	144992	-	-	19,000	28,600	10	PF ZY 1010/6 AR ... GR
	15	6	40	-	-	145081	145098	-	19,000	28,600	10	PF ZY 1015/6 AR ... GR
	25	6	40	-	533925	145128	145135	-	19,000	28,600	10	PF ZY 1025/6 AR ... GR
12	8	6	40	-	-	145913	-	-	16,000	23,800	10	PF ZY 1208/6 AR ... GR
	12	6	40	-	-	145234	-	-	16,000	23,800	10	PF ZY 1212/6 AR ... GR
	20	6	40	-	-	145296	145302	-	16,000	23,800	10	PF ZY 1220/6 AR ... GR
15	15	6	40	-	-	145371	-	-	12,500	19,000	10	PF ZY 1515/6 AR ... GR

Continued on next page

D [mm]	T [mm]	S _d [mm]	L ₂ [mm]	Grit size					Opt. RPM	Max. RPM		Description
				46	80	120	220	400				
EAN 4007220												
15	25	6	40	-	-	145418	145425	-	12,500	19,000	10	PF ZY 1525/6 AR ... GR
	30	6	40	-	-	145470	145487	-	12,500	19,000	10	PF ZY 1530/6 AR ... GR
20	12	6	40	-	-	145982	-	-	9,500	14,300	10	PF ZY 2012/6 AR ... GR
	20	6	40	-	-	145562	145579	-	9,500	14,300	10	PF ZY 2020/6 AR ... GR
	30	6	40	-	534113	145630	-	-	9,500	14,300	10	PF ZY 2030/6 AR ... GR
25	15	6	40	-	-	146026	-	-	7,500	14,300	10	PF ZY 2515/6 AR ... GR
	25	6	40	-	-	145708	145715	-	7,500	11,400	10	PF ZY 2525/6 AR ... GR
30	20	6	40	-	-	146057	-	-	6,500	9,500	5	PF ZY 3020/6 AR ... GR
	30	6	40	-	-	145760	-	-	6,500	9,500	5	PF ZY 3030/6 AR ... GR

Shank dia. 8 mm GR

40	25	8	40	-	-	146095	-	-	4,500	9,500	5	PF ZY 4025/8 AR ... GR
----	----	---	----	---	---	--------	---	---	-------	-------	---	------------------------

Shank dia. 3 mm GHR

4	8	3	30	-	-	-	-	533734	100,000	143,200	10	PF ZY 0408/3 AW ... GHR
8	12	3	30	-	-	533765	-	-	60,000	71,600	10	PF ZY 0812/3 ANCN ... GHR
						-	-	533772	60,000	71,600	10	PF ZY 0812/3 AW ... GHR
10	10	3	30	-	-	533871	-	-	45,000	57,200	10	PF ZY 1010/3 ANCN ... GHR
	15	3	30	-	-	533895	-	-	45,000	52,000	10	PF ZY 1015/3 ANCN ... GHR

Shank dia. 6 mm GHR

10	25	6	40	-	-	533956	-	-	45,000	57,200	10	PF ZY 1025/6 ANCN ... GHR
						-	-	533970	45,000	57,200	10	PF ZY 1025/6 AW ... GHR
15	30	6	40	145555	534069	-	-	-	32,000	47,700	10	PF ZY 1530/6 ANCN ... GHR
20	30	6	40	145692	-	-	-	-	24,000	28,600	10	PF ZY 2030/6 ANCN ... GHR
25	25	6	40	145753	-	-	-	-	19,000	22,900	10	PF ZY 2525/6 ANCN ... GHR

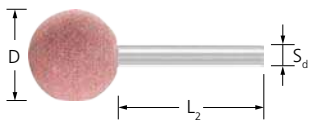

Poliflex fine grinding points PF KU GR/GHR

Fine grinding points in ball shape for fine grinding inner radii, contours and transitions.

Ordering notes:

- Please complete the description with the desired grit size.

D [mm]	S _d [mm]	L ₂ [mm]	Grit size		Opt. RPM	Max. RPM		Description
			120	EAN 4007220				

Shank dia. 3 mm

8	3	30	146217		24,000	35,800	10	PF KU 08/3 AR ... GR
10	3	30	146231		19,000	28,600	10	PF KU 10/3 AR ... GR

Shank dia. 6 mm

12	6	40	146255		16,000	23,800	10	PF KU 12/6 AR ... GR
15	6	40	146279		12,500	19,000	10	PF KU 15/6 AR ... GR
20	6	40	146293		9,500	14,300	10	PF KU 20/6 AR ... GR
25	6	40	146316		7,500	11,400	10	PF KU 25/6 AR ... GR
30	6	40	146323		6,500	9,500	5	PF KU 30/6 AR ... GR

Poliflex fine grinding discs/lenses PF SC/LI GR/GHR





Ideally suited to very fine grinding on all metallic materials, e.g. in tool- and mould-making, in the dental sector and in the jewellery sector.

Due to their construction, the small diameter variants are particularly suited to work on tight and hard-to-reach places.

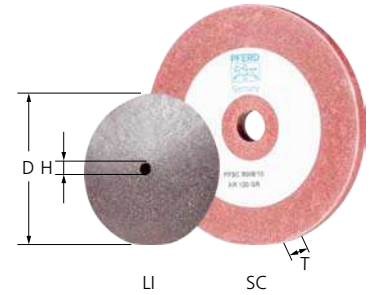
Ordering notes:

- Please order the matching arbor separately.
- Please complete the description with the desired grit size.



D [mm]	T [mm]	H [mm]	Grit size		Opt. RPM	Max. RPM	Suitable arbors		Description
			120	220					
			EAN 4007220						
Disc shape GR 									
25	3	2	146699	-	7,500	11,400	BO 2,3/1,6 1-5, BO 3/1,6 1-5	100	PF SC 2503/2 AR ... GR
30	6	6	144695	-	6,300	9,500	BO 6/6 3-10	5	PF SC 3006/6 AR ... GR
50	6	6	144718	-	3,800	5,700	BO 6/6 3-10	5	PF SC 5006/6 AR ... GR
80	6	10	144756	-	2,400	3,500	BO 8/10 6-20	5	PF SC 8006/10 AR ... GR
100	20	10	144787	-	1,900	2,800	BO 8/10 6-20	1	PF SC 10020/10 AR ... GR
Disc shape GHR 									
25	3	2	-	146705	7,500	11,400	BO 2,3/1,6 1-5, BO 3/1,6 1-5	100	PF SC 2503/2 CU ... GHR
Lens shape GHR 									
16	4	2	-	146675	12,000	17,900	BO 2,3/1,6 1-5, BO 3/1,6 1-5	100	PF LI 1604/2 CU ... GHR
24	3	2	-	146682	8,000	12,000	BO 2,3/1,6 1-5, BO 3/1,6 1-5	100	PF LI 2403/2 CU ... GHR

Arbors BO

Matching arbor for Poliflex fine grinding discs and lenses PF SC/LI.

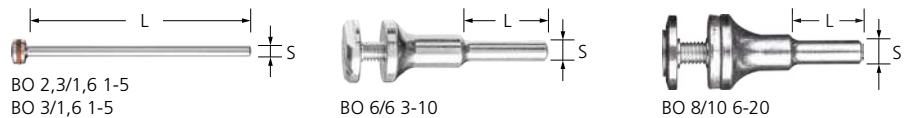

Advantages:

- High economic efficiency as the tool can be changed quickly.

Suitable for centre hole dia. [mm]	S [mm]	L [mm]	Clamping width [mm]	EAN 4007220		Description
1.6	2.34	43	1-5	151570	10	BO 2,3/1,6 1-5
	3	43	1-5	151587	10	BO 3/1,6 1-5
6	6	25	3-10	297650	1	BO 6/6 3-10
10	8	30	6-20	297667	1	BO 8/10 6-20

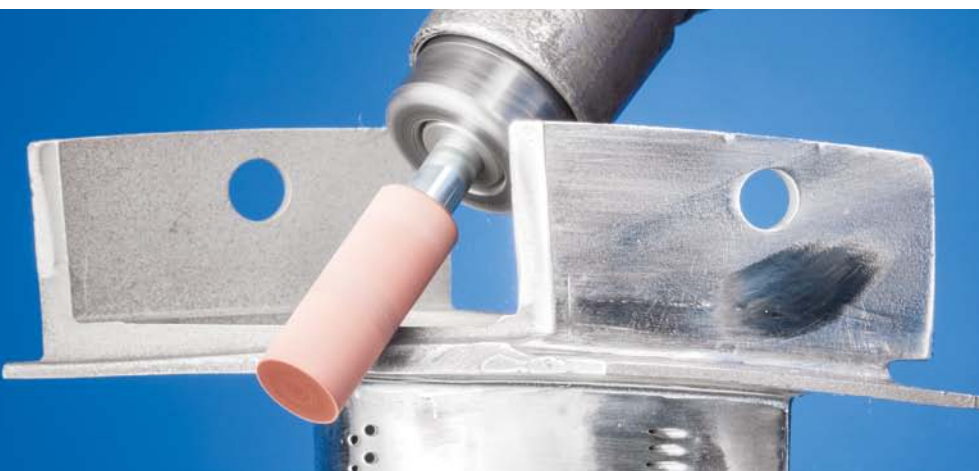



Poliflex fine grinding tools with the LR bond are manufactured with white aluminium oxide. The LR bond is a hard, sturdy bond. Suitable for use on surfaces.

Poliflex fine grinding tools with the LHR bond are manufactured with an abrasive grain mixture comprising white aluminium oxide and a portion of green silicon carbide. The LHR bond is a hard, sturdy bond. Suitable for use on edges.

Advantages:

- For achieving a fine, shiny surface finish.
- High profitability thanks to high abrasive performance and long tool life.

Abrasive:

- Aluminium oxide A
- Silicon carbide SiC

Applications:

- Step-by-step fine grinding

Matching tool drives:

- Flexible shaft drives
- Straight grinders

Recommendations for use:

- Depending on the application, profile with a diamond dresser or with ceramic dressing stones at a low rotational speed. Please refer to catalogue section 3 for detailed information and ordering data for dressing tools.
- **LR:** For best performance, use with a recommended cutting speed of 15–20 m/s.
- **LHR:** For best performance, use with a recommended cutting speed of 30–40 m/s.

Ordering notes:

- When ordering, please state the EAN or the full description.

Safety notes:

- For safety reasons, the specified maximum permitted rotational speed must never be exceeded.
- The clamping length of the shank must be at least 10 mm.

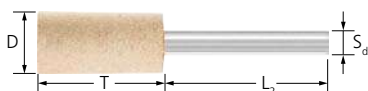

Poliflex fine grinding points PF ZY LR/LHR

Fine grinding points in cylindrical shape, for fine grinding of small surfaces.

Ordering notes:

- Poliflex fine grinding points LHR with a grit size of 60 are manufactured from an

abrasive mixture of AWCN white aluminium oxide and green silicon carbide.

- Please complete the description with the desired grit size.

D [mm]	T [mm]	S _d [mm]	L ₂ [mm]	Grit size				Opt. RPM	Max. RPM		Description
				60	120	220	400				
				EAN 4007220							
Shank dia. 3 mm LR											
4	8	3	30	-	144817	-	533697	95,000	143,200	10	PF ZY 0408/3 AW ... LR
6	10	3	30	-	144831	-	-	64,000	95,400	10	PF ZY 0610/3 AW ... LR
8	8	3	30	-	144862	-	-	47,500	71,600	10	PF ZY 0808/3 AW ... LR
	12	3	30	-	144909	144916	533758	47,500	71,600	10	PF ZY 0812/3 AW ... LR
10	10	3	30	-	144961	144978	-	38,000	57,200	10	PF ZY 1010/3 AW ... LR
	15	3	30	-	145050	-	-	38,000	57,200	10	PF ZY 1015/3 AW ... LR
12	12	3	30	-	145210	-	-	32,000	47,700	10	PF ZY 1212/3 AW ... LR
	20	3	30	-	145272	-	-	32,000	47,700	10	PF ZY 1220/3 AW ... LR
Shank diameter of 6 mm LR											
10	10	6	40	-	145012	-	-	38,000	57,200	10	PF ZY 1010/6 AW ... LR
	15	6	40	-	145104	-	-	38,000	57,200	10	PF ZY 1015/6 AW ... LR
	25	6	40	-	145142	145159	-	38,000	57,200	10	PF ZY 1025/6 AW ... LR
12	12	6	40	-	145258	-	-	32,000	47,700	10	PF ZY 1212/6 AW ... LR
	20	6	40	-	145319	-	-	32,000	47,700	10	PF ZY 1220/6 AW ... LR
15	15	6	40	-	145395	-	-	25,500	38,100	10	PF ZY 1515/6 AW ... LR
	25	6	40	-	145449	-	-	25,500	38,100	10	PF ZY 1525/6 AW ... LR
	30	6	40	-	145500	-	-	25,500	38,100	10	PF ZY 1530/6 AW ... LR

Continued on next page

D [mm]	T [mm]	S _d [mm]	L ₂ [mm]	Grit size				Opt. RPM	Max. RPM		Description
				60	120	220	400				
				EAN 4007220							
20	20	6	40	-	145593	-	-	19,000	28,600	10	PF ZY 2020/6 AW ... LR
20	30	6	40	-	145661	-	-	19,000	28,600	10	PF ZY 2030/6 AW ... LR
25	25	6	40	-	145739	-	-	15,000	22,900	10	PF ZY 2525/6 AW ... LR
30	30	6	40	-	145791	-	-	12,500	19,000	5	PF ZY 3030/6 AW ... LR
Shank dia. 3 mm LHR											
8	12	3	30	-	144923	-	-	47,000	76,700	10	PF ZY 0812/3 AW ... LHR
Shank dia. 6 mm LHR											
10	25	6	40	145166	-	-	-	75,000	83,200	10	PF ZY 1025/6 AWCN ... LHR
				-	145173	-	-	75,000	83,200	10	PF ZY 1025/6 AW ... LHR
20	20	6	40	-	145616	-	-	38,000	47,700	10	PF ZY 2020/6 AW ... LHR

Poliflex fine grinding points PF KU LR/LHR

Fine grinding points in ball shape for fine grinding inner radii, contours and transitions.

Ordering notes:

- Please complete the description with the desired grit size.

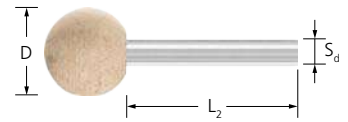

D [mm]	S _d [mm]	L ₂ [mm]	Grit size		Opt. RPM	Max. RPM		Description
			120					
			EAN 4007220					
Shank dia. 3 mm								
8	3	30	146224		47,000	71,600	10	PF KU 08/3 AW ... LR
10	3	30	146248		38,000	57,200	10	PF KU 10/3 AW ... LR
Shank dia. 6 mm								
15	6	40	146286		29,500	38,100	10	PF KU 15/6 AW ... LR
20	6	40	146309		19,000	28,600	10	PF KU 20/6 AW ... LR



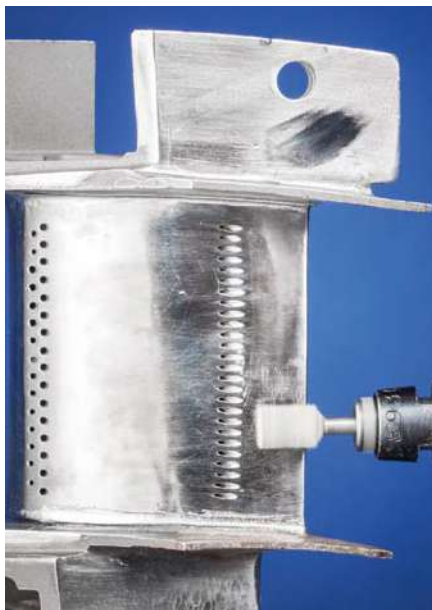

Poliflex fine grinding tools with the TX bond are manufactured with standard aluminium oxide. The textile fabric inlays make the TX bond a very hard, sturdy bond. Suitable for use on edges.

Advantages:

- For achieving a fine, matt surface finish.
- High profitability thanks to high abrasive performance and long tool life.

Abrasive:

- Aluminium oxide A

Applications:

- Step-by-step fine grinding

Matching tool drives:

- Flexible shaft drives
- Straight grinders

Recommendations for use:

- Depending on the application, profile with a diamond dresser or with ceramic dressing stones at a low rotational speed. Please refer to catalogue section 3 for detailed information and ordering data for dressing tools.
- For best performance, use with a recommended cutting speed of 20–30 m/s.
- The 19 x 2.5 mm dimension variant is ideally suited to grinding tracks.

Ordering notes:

- When ordering, please state the EAN or the full description.

Safety notes:

- For safety reasons, the specified maximum permitted rotational speed must never be exceeded.
- The clamping length of the shank must be at least 10 mm.



Poliflex fine grinding points PF ZY TX

Fine grinding points in cylindrical shape, for fine grinding of small surfaces.

Recommendations for use:

- The dimensions of 19 x 2.5 mm have been specifically designed for cleaning and slot grinding applications. Seat mounting rails (tracks) in passenger aircraft can be cleaned and rust removed.

Ordering notes:

- Please complete the description with the desired grit size.

D [mm]	T [mm]	S _d [mm]	L ₂ [mm]	Grit size		Opt. RPM	Max. RPM		Description
				80	120				
				EAN 4007220					

Shank dia. 3 mm

6	10	3	30	298060	298077	63,000	95,400	10	PF ZY 0610/3 AN ... TX
8	12	3	30	298084	298091	47,500	71,600	10	PF ZY 0812/3 AN ... TX

Shank dia. 6 mm

10	25	6	40	297780	297889	38,000	57,200	10	PF ZY 1025/6 AN ... TX
16	32	6	40	297919	297940	24,000	35,800	10	PF ZY 1632/6 AN ... TX
19	2.5	6	40	067857	-	20,000	30,100	10	PF ZY 192,5 6 AN ... TX
20	32	6	40	297957	297964	19,000	28,600	10	PF ZY 2032/6 AN ... TX
25	32	6	40	297988	297995	15,000	22,900	10	PF ZY 2532/6 AN ... TX

Poliflex fine grinding points PF KU TX

Fine grinding points in ball shape for fine grinding inner radii, contours and transitions.

Ordering notes:

- Please complete the description with the desired grit size.

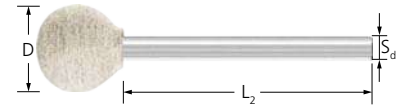

D [mm]	S _d [mm]	L ₂ [mm]	Grit size		Opt. RPM	Max. RPM		Description
			80	120				
			EAN 4007220					

Shank dia. 3 mm

6	3	30	298145	298152	63,000	95,400	10	PF KU 06/3 AN ... TX
8	3	30	-	298176	47,500	71,600	10	PF KU 08/3 AN ... TX
10	3	30	-	298190	38,000	57,200	10	PF KU 10/3 AN ... TX

Poliflex fine grinding points PF KE TX

Fine grinding points in conical shape for fine grinding inner radii, contours and transitions.

Ordering notes:

- Please complete the description with the desired grit size.



D [mm]	T [mm]	S _d [mm]	L ₂ [mm]	Grit size		Opt. RPM	Max. RPM		Description
				80	120				
				EAN 4007220					

Shank dia. 6 mm

10	25	6	40	298121	298138	38,000	57,200	10	PF KE 1025/6 AN ... TX
16	45	6	40	298015	-	24,000	38,800	10	PF KE 1645/6 AN ... TX
25	70	6	40	298008	-	15,000	22,900	10	PF KE 2570/6 AN ... TX

Poliflex fine grinding points PF SP TX

Fine grinding points in pointed tree shape for fine grinding inner radii, contours and transitions.

Ordering notes:

- Please complete the description with the desired grit size.



D [mm]	T [mm]	S _d [mm]	L ₂ [mm]	Grit size		Opt. RPM	Max. RPM		Description
				80	120				
				EAN 4007220					

Shank dia. 3 mm

10	20	3	30	298107	298114	38,000	57,200	10	PF SP 1020/3 AN ... TX
----	----	---	----	--------	--------	--------	--------	----	------------------------

Shank dia. 6 mm

20	32	6	40	298039	298046	19,000	28,600	10	PF SP 2032/6 AN ... TX
----	----	---	----	--------	--------	--------	--------	----	------------------------



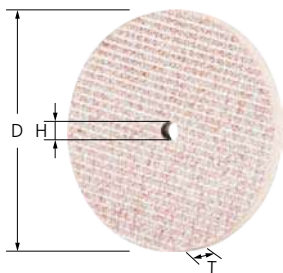

Poliflex fine grinding discs PF SC TX

For fine peripheral grinding of small surfaces.

Ordering notes:

- Please order the matching arbor separately.
- Please complete the description with the desired grit size.

D [mm]	T [mm]	H [mm]	Grit size		Opt. RPM	Max. RPM	Suitable arbors		Description
			80	120					
			EAN 4007220						
25	3	3	505502	505519	15,000	22,900	BO 6/3 1-6	20	PF SC 2503/3 A ... TX
	6	3	-	505540	15,000	22,900	BO 6/3 1-6	20	PF SC 2506/3 A ... TX
40	3	3	505564	505571	9,500	14,300	BO 6/3 1-6	10	PF SC 4003/3 A ... TX
	6	6	-	505618	9,500	14,300	BO 6/6 3-10	10	PF SC 4006/6 A ... TX



BO 6/3 1-6

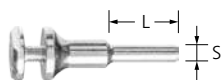

BO 6/6 3-10

Arbors BO

Matching arbor for Poliflex fine grinding discs PF SC.

Advantages:

- High economic efficiency as the tool can be changed quickly.

Suitable for centre hole dia. [mm]	S [mm]	L [mm]	Clamping width [mm]	EAN 4007220		Description
3	6	40	1-6	505694	1	BO 6/3 1-6
6	6	25	3-10	297650	1	BO 6/6 3-10

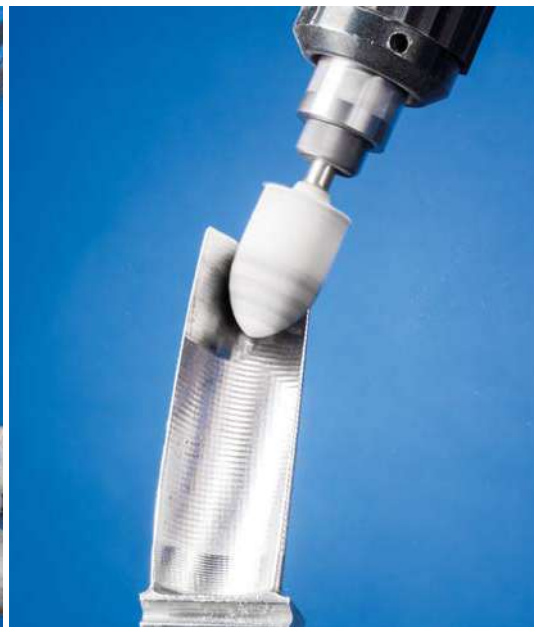

Ceramic fibre files are made of high-grade ceramic fibres directionally embedded in a special resinoid bond. Suitable for use on surfaces and in hard-to-reach areas in tool- and mould-making.

Advantages:

- High profitability thanks to high abrasive performance and long tool life.
- For achieving very good surface quality standards.

Abrasive:

- Ceramic fibres
- Grit size colour code:
 - 180 = Gold
 - 280 = Light brown
 - 400 = Orange
 - 700 = Blue

Materials that can be worked:

- Aluminium
- Copper
- Stainless steel (INOX)
- Steel, cast steel

Applications:

- Surface work
- Finishing
- Step-by-step fine grinding

Matching tool drives:

- Manual application
- Manual filing tool

Recommendations for use:

- Use the files at a 45° angle for the highest stock removal rate.

Safety notes:



Ceramic fibre files

4





KFF

The various shapes enable work on difficult geometries in tool-making applications.

Ordering notes:

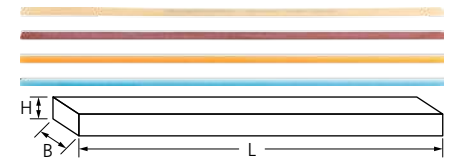
- Please complete the description with the desired grit size.



H [mm]	B [mm]	L [mm]	Grit size				Description
			180	280	400	700	
EAN 4007220							
Flat <input type="checkbox"/>							
0.5	4	150	668887	668894	668900	668917	1 KFF 0,5 x 4 x 150 A ...
1	4	150	668924	668931	668948	668955	1 KFF 1,0 x 4 x 150 A ...
2	4	150	668962	668979	668986	668993	1 KFF 2,0 x 4 x 150 A ...
0.5	6	150	669006	669013	669020	669037	1 KFF 0,5 x 6 x 150 A ...
1	6	150	669044	669051	669068	669075	1 KFF 1,0 x 6 x 150 A ...
2	6	150	669082	669099	669105	669112	1 KFF 2,0 x 6 x 150 A ...
1	10	150	669129	669136	669143	669150	1 KFF 1,0 x 10 x 150 A ...
Round <input type="radio"/>							
2.35	-	150	026724	026748	026755	026762	1 KFF RD 2,35 x 150 A ...
3	-	150	026779	026786	026793	026809	1 KFF RD 3 x 150 A ...
Three square <input type="checkbox"/>							
3	3	150	026816	026823	026830	026847	1 KFF DKT 3 x 3 x 3 x 150 A ...



Detailed information on grinding and polishing stones can be found in catalogue section 3.

Polishing tools

General information

The comprehensive range of polishing tools contains:

- Felt points
- Mounted felt flap wheels
- Felt wheels
- Felt flap discs
- Cloth rings

Felt points and discs are available in two types:

■ **Felt points/discs without metal inlay:**

These are predominantly used for high-gloss polishing

■ **Felt points/discs with metal inlay (MS):**

These are used for increased stock removal when pre-polishing with diamond grinding pastes.

Advantages:

- Felt points and discs: Precise retention of geometric shapes due to the hardness of these tools.
- Felt flap discs, cloth rings and mounted felt flap wheels: Optimum adaptation to contours thanks to high flexibility.
- Can be freely shaped, meaning they can be used for tools with complicated geometries.

Materials that can be worked:

- Can be used on nearly all materials.

Applications:

- Polishing

Recommendations for use:

- For best performance, use with a recommended cutting speed of 5–10 m/s. This provides an ideal compromise between stock removal rate, surface quality, thermal load on the workpiece and tool wear.
- **Felt points and discs:** Use diamond polishing pastes and polishing paste bars.
- **Cloth rings and mounted felt flap wheels:** Use polishing and grinding pastes.
- When changing the polishing paste, use a brand-new polishing tool.

Ordering instructions:

- When ordering, please state the EAN or the full description.
- **Ordering example:**
EAN 4007220295243
FK ZYA 0610/3 M
- **Ordering example explanation:**
FK = Felt point
ZYA = Cylindrical shape
0610 = Outer diameter D x width T [mm]
3 = Shank diameter S_d [mm]
M = Medium hardness

Safety notes:

- For safety reasons, the specified maximum permitted rotational speed must never be exceeded.



Recommended rotational speed range

Example:

FK ZYA 2530/6 ST-BO

Cutting speed: 5–10 m/s

Rotational speed: 3,800-7,600 RPM

Example:

TR 10010 ST/10

Cutting speed: 10–15 m/s

Rotational speed: 1,900-2,800 RPM

Tool dia. [mm]	Cutting speed [m/s]					
	5	10	15	20	25	32
	Rotational speeds [RPM]					
6	15,900	31,800	47,700	63,600	79,500	101,800
8	11,900	23,800	35,800	47,700	59,600	76,300
10	9,500	19,000	28,600	38,100	47,700	61,100
12	7,900	15,900	23,800	31,800	39,700	50,900
15	6,300	12,700	19,000	25,400	31,800	40,700
20	4,700	9,500	14,300	19,000	23,800	30,500
25	3,800	7,600	11,400	15,200	19,000	24,400
30	3,100	6,300	9,500	12,700	15,900	20,300
45	2,100	4,200	6,300	8,400	10,600	13,500
60	1,500	3,100	4,700	6,300	7,900	10,100
80	1,100	2,300	3,500	4,700	5,900	7,600
100	900	1,900	2,800	3,800	4,700	6,100
115	800	1,600	2,400	3,300	4,100	5,300
125	700	1,500	2,200	3,000	3,800	4,800
150	600	1,200	1,900	2,500	3,100	4,000
200	400	900	1,400	1,900	2,300	3,000

Shape ZYA

The cylindrical shape ZYA is mainly used peripherally. The variant with end hole (ST-BO) is particularly suitable for face-down use.

Felt points with metal inserts (MS) are used for increased stock removal when pre-polishing with diamond polishing pastes.

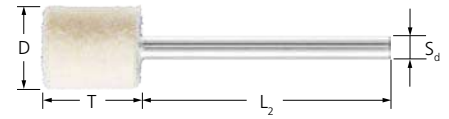

Matching tool drives:
flexible shaft drive, straight grinder

Ordering notes:
■ Please complete the description with the desired type.

D [mm]	T [mm]	S _d [mm]	L ₂ [mm]	Type			Opt. RPM	Max. RPM		Description
				M (medium)	H (hard)	MS (metal insert)				
EAN 4007220										
Shank dia. 2.35 mm										
4	12	2.35	34	035757	-	-	23,000–47,000	119,000	10	FK ZYA 0412/2,35 ...
6	10	2.35	35	035771	035788	-	16,000–32,000	79,500	10	FK ZYA 0610/2,35 ...
8	10	2.35	35	035818	035825	-	12,000–24,000	59,500	10	FK ZYA 0810/2,35 ...
Shank dia. 3 mm										
4	12	3	37	035764	-	-	23,000–47,000	119,000	10	FK ZYA 0412/3 ...
6	10	3	35	295243	035795	-	16,000–32,000	79,500	10	FK ZYA 0610/3 ...
8	10	3	35	295250	035832	-	12,000–24,000	59,500	10	FK ZYA 0810/3 ...
10	12	3	34	035849	035856	-	10,000–20,000	47,500	10	FK ZYA 1012/3 ...
	15	3	32	153871	035887	295304	10,000–20,000	47,500	10	FK ZYA 1015/3 ...
12	20	3	28	035917	035924	-	7,950–15,900	39,500	10	FK ZYA 1220/3 ...
Shank dia. 3 mm – end hole										
15	20	3	28	035955	035962	-	6,000–12,000	31,500	10	FK ZYA 1520/3 ... ST-BO
Shank dia. 6 mm										
10	12	6	42	035863	035870	-	10,000–20,000	47,500	10	FK ZYA 1012/6 ...
	15	6	40	153772	035894	-	10,000–20,000	47,500	10	FK ZYA 1015/6 ...
12	20	6	36	035931	035948	-	7,950–15,900	39,500	10	FK ZYA 1220/6 ...
Shank dia. 6 mm – end hole										
15	20	6	38	294727	035979	295311	6,000–12,000	31,500	10	FK ZYA 1520/6 ... ST-BO
20	25	6	43	153802	035986	295328	5,000–10,000	23,500	10	FK ZYA 2025/6 ... ST-BO
25	30	6	40	153888	036006	295335	4,000–8,000	19,000	10	FK ZYA 2530/6 ... ST-BO



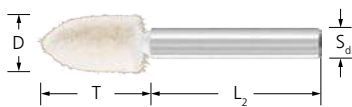

Shape SPK

The conical pointed shape SPK is mainly used for work on radii and contours.

Matching tool drives:
flexible shaft drive, straight grinder

Ordering notes:
■ Please complete the description with the desired type.

D [mm]	T [mm]	S _d [mm]	L ₂ [mm]	Type		Opt. RPM	Max. RPM		Description
				M (medium)	H (hard)				

EAN 4007220

Shank dia. 2.35 mm

6	10	2.35	37	036013	036020	16,000–32,000	79,500	10	FK SPK 0610/2,35 ...
	18	2.35	33	036044	036068	16,000–32,000	79,500	10	FK SPK 0618/2,35 ...
8	12	2.35	36	036099	036105	12,000–24,000	59,500	10	FK SPK 0812/2,35 ...

Shank dia. 3 mm

6	10	3	37	588666	036037	16,000–32,000	79,500	10	FK SPK 0610/3 ...
	18	3	33	036051	036075	16,000–32,000	79,500	10	FK SPK 0618/3 ...
8	12	3	36	295267	036112	12,000–24,000	59,500	10	FK SPK 0812/3 ...
10	18	3	33	153925	036129	10,000–20,000	47,500	10	FK SPK 1018/3 ...
12	18	3	33	295274	-	8,000–16,000	39,500	10	FK SPK 1218/3 ...

Shank dia. 6 mm

10	18	6	41	153796	036136	10,000–20,000	47,500	10	FK SPK 1018/6 ...
15	20	6	42	153932	-	6,000–12,000	31,500	10	FK SPK 1520/6 ...
	30	6	45	153949	-	6,000–12,000	31,500	10	FK SPK 1530/6 ...
20	25	6	47	294734	-	5,000–10,000	23,500	10	FK SPK 2025/6 ...
25	30	6	45	588710	-	4,000–8,000	19,000	10	FK SPK 2530/6 ...
30	35	6	42	588727	-	3,200–6,350	15,500	10	FK SPK 3035/6 ...



Shape KEL

The conical shape KEL is mainly used for work on radii.

Matching tool drives:
flexible shaft drive, straight grinder

Ordering notes:
■ Please complete the description with the desired type.

D [mm]	T [mm]	S _d [mm]	L ₂ [mm]	Type		Opt. RPM	Max. RPM		Description
				M (medium)	H (hard)				

EAN 4007220

Shank dia. 2.35 mm

6	10	2.35	37	036143	-	16,000–32,000	79,500	10	FK KEL 0610/2,35 ...
---	----	------	----	--------	---	---------------	--------	----	----------------------

Shank dia. 3 mm

6	10	3	37	588734	-	16,000–32,000	79,500	10	FK KEL 0610/3 ...
10	15	3	34	588765	-	10,000–20,000	47,500	10	FK KEL 1015/3 ...

Shank dia. 6 mm

10	15	6	40	588840	-	10,000–20,000	47,500	10	FK KEL 1015/6 ...
15	20	6	42	294741	-	6,000–12,000	31,500	10	FK KEL 1520/6 ...
20	25	6	47	153956	036150	5,000–10,000	23,500	10	FK KEL 2025/6 ...
	30	6	45	036167	036174	5,000–10,000	23,500	10	FK KEL 2030/6 ...
25	30	6	45	153819	-	4,000–8,000	19,000	10	FK KEL 2530/6 ...
30	35	6	42	153826	-	3,200–6,350	15,500	10	FK KEL 3035/6 ...

Shape WRC

The cylindrical shape with radius end WRC is mainly used for work on small, concave contours.

Matching tool drives:
 flexible shaft drive, straight grinder

Ordering notes:
 ■ Please complete the description with the desired type.

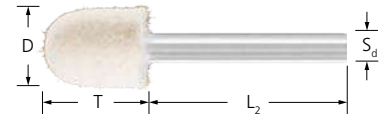

D [mm]	T [mm]	S _d [mm]	L ₂ [mm]	Type	Opt. RPM	Max. RPM		Description
				M				
				EAN 4007220				

Shank dia. 2.35 mm

6	10	2.35	37	036181	16,000–32,000	79,500	10	FK WRC 0610/2,35 ...
8	12	2.35	36	036204	12,000–24,000	59,500	10	FK WRC 0812/2,35 ...
10	14	2.35	35	036211	10,000–20,000	47,500	10	FK WRC 1014/2,35 ...

Shank dia. 3 mm

6	10	3	36	588451	16,000–32,000	79,500	10	FK WRC 0610/3 ...
8	12	3	43	295281	12,000–24,000	59,500	10	FK WRC 0812/3 ...
10	14	3	35	295298	10,000–20,000	47,500	10	FK WRC 1014/3 ...

Shank dia. 6 mm

15	20	6	42	153895	6,000–12,000	31,500	10	FK WRC 1520/6 ...
20	25	6	47	153901	5,000–10,000	23,500	10	FK WRC 2025/6 ...
25	30	6	45	153918	4,000–8,000	19,000	10	FK WRC 2530/6 ...

Shape TRE

The oval shape TRE is mainly used for work on small radii.

Matching tool drives:
 flexible shaft drive, straight grinder

Ordering notes:
 ■ Please complete the description with the desired type.

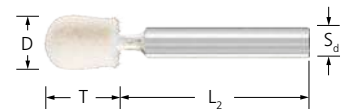

D [mm]	T [mm]	S _d [mm]	L ₂ [mm]	Type	Opt. RPM	Max. RPM		Description
				M				
				EAN 4007220				

Shank dia. 2.35 mm

6	10	2.35	37	036228	16,000–32,000	79,500	10	FK TRE 0610/2,35 ...
8	12	2.35	36	036242	12,000–24,000	59,500	10	FK TRE 0812/2,35 ...
10	14	2.35	35	036266	10,000–20,000	47,500	10	FK TRE 1014/2,35 ...

Shank dia. 3 mm

6	10	3	37	036235	16,000–32,000	79,500	10	FK TRE 0610/3 ...
8	12	3	36	036259	12,000–24,000	59,500	10	FK TRE 0812/3 ...
10	14	3	35	036273	10,000–20,000	47,500	10	FK TRE 1014/3 ...

Shank dia. 6 mm

10	14	6	43	153789	10,000–20,000	47,500	10	FK TRE 1014/6 ...
----	----	---	----	--------	---------------	--------	----	-------------------



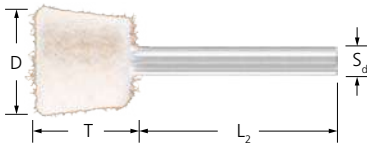

Shape WKN

The tapered shape WKN is mainly used for work on interior angles.

Matching tool drives:
flexible shaft drive, straight grinder

Ordering notes:
■ Please complete the description with the desired type.

D [mm]	T [mm]	S _d [mm]	L ₂ [mm]	Type		Opt. RPM	Max. RPM		Description
				M (medium)	H (hard)				
EAN 4007220									
Shank dia. 2.35 mm									
10	15	2.35	32	036280	-	10,000–20,000	47,500	10	FK WKN 1015/2,35 ...
12	12	2.35	34	036303	036327	8,000–16,000	39,500	10	FK WKN 1212/2,35 ...
Shank dia. 3 mm									
10	15	3	32	036297	-	10,000–20,000	47,500	10	FK WKN 1015/3 ...
12	12	3	36	036310	036334	8,000–16,000	39,500	10	FK WKN 1212/3 ...
15	15	3	32	036341	036358	6,000–12,000	31,500	10	FK WKN 1515/3 ...
20	16	3	28	036365	-	5,000–10,000	23,500	10	FK WKN 2016/3 ...
Shank dia. 6 mm									
20	16	6	38	294758	-	5,000–10,000	23,500	10	FK WKN 2016/6 ...

Mounted felt flap wheels FLS

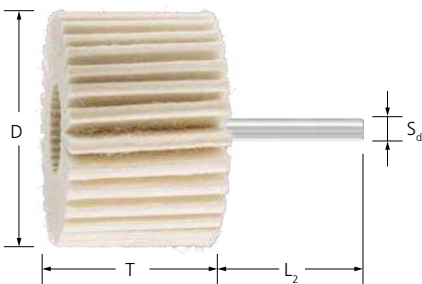

FLS

Mounted felt flap wheels are used for pre-polishing and high-gloss polishing on small to medium-sized components.

Advantages:
■ Low thermal load on the workpiece.

Recommendations for use:
■ Use the hard type for pre-polishing flat surfaces, and the soft type for high-gloss polishing and processing workpieces with lots of contours.

■ If very fine finishes need to be achieved, the two types can be used successively.

Matching tool drives:
flexible shaft drive, straight grinder

Ordering notes:
■ Please complete the description with the desired type.

D [mm]	T [mm]	S _d [mm]	L [mm]	Type		Opt. RPM	Max. RPM		Description
				W (soft)	H (hard)				
EAN 4007220									
30	20	6	40	936160	936177	6,300	20,000	5	FLS 3020/6 ...
40	20	6	40	936184	936191	4,750	15,000	5	FLS 4020/6 ...
50	30	6	40	936207	936214	3,800	12,000	5	FLS 5030/6 ...
60	40	6	40	936221	936238	3,150	10,000	5	FLS 6040/6 ...
80	50	6	40	936245	936252	2,400	7,500	5	FLS 8050/6 ...



FK SC/LI

Felt wheels and lenses are mainly used peripherally.

Felt wheels with metal inserts (MS) are used for increased stock removal when pre-polishing with diamond grinding pastes.

Matching tool drives:
 flexible shaft drive, straight grinder

Ordering notes:
 ■ Please order the matching arbor separately.
 ■ Please complete the description with the desired type.

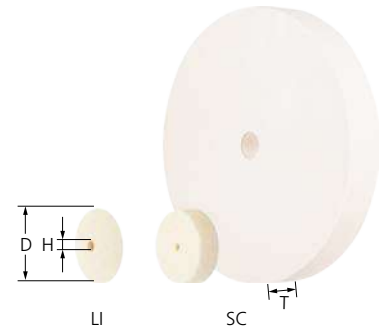

D [mm]	T [mm]	H [mm]	Type			Opt. RPM	Max. RPM	Suitable arbors		Description
			M (medium)	H (hard)	MS (metal insert)					
			EAN 4007220							

Lenses

17	5	2	-	036402	-	5,600–11,000	28,000	BO 2,3/1,6 1-5, BO 3/1,6 1-5	10	FK LI 1705/2 ...
22	5	2	-	036419	-	4,300–8,650	21,700	BO 2,3/1,6 1-5, BO 3/1,6 1-5	10	FK LI 2205/2 ...

Wheels

17	5	2	036372	-	-	5,600–11,000	28,000	BO 2,3/1,6 1-5, BO 3/1,6 1-5	10	FK SC 1705/2 ...
20	5	2	036389	-	-	5,000–10,000	23,500	BO 2,3/1,6 1-5, BO 3/1,6 1-5	10	FK SC 2005/2 ...
30	5	2	036396	-	-	3,000–6,000	20,000	BO 2,3/1,6 1-5, BO 3/1,6 1-5	10	FK SC 3005/2 ...
			153864	-	-	3,000–6,000	20,000	BO 6/6 3-10	5	FK SC 3007/6 ...
45	9	6	153840	-	-	2,000–4,000	13,500	BO 6/6 3-10	5	FK SC 4509/6 ...
60	10	6	297605	-	-	1,500–3,000	10,000	BO 6/6 3-10	5	FK SC 6010/6 ...
80	10	10	154069	-	295342	1,000–2,000	7,500	BO 8/10 6-20	5	FK SC 8010/10 ...
100	20	10	297612	-	295359	900–1,800	6,100	BO 8/10 6-20	1	FK SC 10020/10 ...
125	20	20	297629	-	295366	750–1,500	4,900	BO 12/20 10-50, BO MK 1/20 10-50	1	FK SC 12520/20 ...
150	25	20	297636	-	-	600–1,200	4,000	BO 12/20 10-50, BO MK 1/20 10-50	1	FK SC 15025/20 ...
200	30	20	297643	-	-	500–1,000	3,000	BO 12/20 10-50, BO MK 1/20 10-50	1	FK SC 20030/20 ...



Felt flap discs FFS

FFS

Felt flap discs are used for pre-polishing and high-gloss polishing on medium-sized to large components.

Advantages:
 ■ Low thermal load on the workpiece.

Matching tool drives:
 angle grinder, cordless angle grinder

Recommendations for use:
 ■ Use the hard type for pre-polishing flat surfaces, and the soft type for high-gloss polishing and processing workpieces with lots of contours.
 ■ If very fine finishes need to be achieved, the two types can be used successively.

Ordering notes:
 ■ Please complete the description with the desired type.



D [mm]	T [mm]	H [mm]	Type		Opt. RPM	Max. RPM		Description
			W (soft)	H (hard)				
			EAN 4007220					
115	22	22.23	936085	936139	1,650	8,350	5	FFS 115/22,23 ...
125	22	22.23	936146	936153	1,500	7,650	5	FFS 125/22,23 ...

Polishing tools

Felt sheets FK P

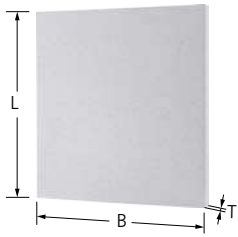

FK P

Felt sheets are suited to a very wide variety of polishing applications. The two different hardness grades available only multiply the number of potential applications.

Advantages:

- Depending on the requirements, can be cut or punched into any shape (e.g. rectangle, square, stick or wheel) quickly and easily.

Matching tool drives:

manual application

Ordering notes:

- Please complete the description with the desired type.

L [mm]	B [mm]	T [mm]	Type			Description
			M (medium)	H (hard)		
			EAN 4007220			
250	250	3	036433	-	1	FK P 250-250-3 ...
		6	036440	036457	1	FK P 250-250-6 ...
		12	036464	036471	1	FK P 250-250-12 ...

Cloth rings

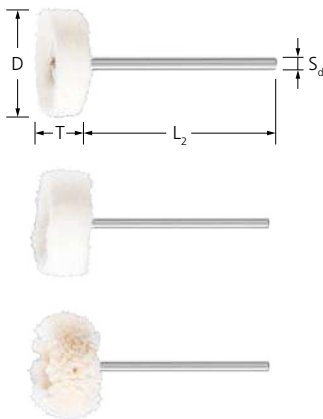

Shank-mounted cloth rings TR

Shank-mounted cloth rings are used with polishing pastes for pre-polishing, gloss polishing and high-gloss polishing in tool- and mould-making applications.

Shank-mounted cloth rings are available in three types:

- BW (cotton) = Very fine high-gloss polishing, dust removal and buffing
- FZ (felt cloth) = Pre-polishing and gloss polishing in combination with appropriate polishing pastes
- FL (flannel) = Buffing, gloss polishing and high-gloss polishing in combination with the appropriate polishing pastes

Recommendations for use:

- Make sure that the tool does not overheat when polishing.
- Use a sufficient amount of polishing paste.

Matching tool drives:

flexible shaft drive, straight grinder

Ordering notes:

- Detailed information and ordering data on polishing pastes can be found on pages 153–154.
- Please complete the description with the desired type.

D [mm]	T [mm]	S _d [mm]	L ₂ [mm]	Type			Opt. RPM	Max. RPM		Description
				BW	FZ	FL				
				EAN 4007220						

Shank dia. 2.35 mm

22	10	2.35	40	034538	034545	034552	13,000	17,350	10	TR 2210/2,35 ...
----	----	------	----	--------	--------	--------	--------	--------	----	------------------

Shank dia. 3 mm

22	10	3	40	034569	034576	034583	13,000	17,350	10	TR 2210/3 ...
----	----	---	----	--------	--------	--------	--------	--------	----	---------------

Cloth rings with centre hole TR

Cloth rings are used for pre-polishing and high-gloss polishing with polishing pastes. If the intention is to achieve very smooth surface finishes, use several or even all variants successively.

Cloth rings are available in four types:
 ST (sisal cloth) = Coarse pre-polishing
 TH (hard cloth) = Pre-polishing
 TW (soft cloth) = High-gloss polishing
 FL (flannel) = High-gloss polishing/buffing

Recommendations for use:

- Pre-polishing of steel and INOX:
Cloth rings ST or TH with polishing paste PP 1 VP STEELOX.
- Pre-polishing of aluminium and brass:
Cloth rings ST or TH with polishing paste PP 2 VP ALU.
- Pre-polishing of non-ferrous metals:
Cloth rings ST or TH with polishing paste PP 3 VP NON-FERROUS.
- High-gloss polishing on all metals:
Cloth rings TW or FL with polishing paste PP 4 UNIVERSAL.
- High-gloss polishing on plastics:
Cloth rings TW or FL with polishing paste PP 5 HGP PLAST.
- Type TW and FL cloth rings achieve their best performance at a recommended cutting speed of 5–15 m/s.
- Type ST and TH cloth rings achieve their best performance at a recommended cutting speed of 10–15 m/s.

Matching tool drives:

flexible shaft drive, straight grinder

Ordering notes:

- Please order arbor separately.
- TR 12510 type ST: 10 mm hole (25.4/6-edge, arbor FR/VR 12/25,4).
- Please complete the description with the desired type.



D [mm]	Used width [mm]	H [mm]	Type				Opt. RPM	Max. RPM	Suitable arbors		Description
			ST	TH	TW	FL					
EAN 4007220											
50	10	6	-	804315	804322	804339	3,800	12,000	BO 6/6 3-10	5	TR 5010-6 ...
80	10	10	294086	294093	294109	294116	2,500	7,500	BO 8/10 6-20	5	TR 8010-10 ...
100	10	10	294123	294130	294147	294154	1,900	6,100	BO 8/10 6-20	5	TR 10010-10 ...
125	10	20	294161	294178	294185	294192	1,300	4,900	BO 12/20 10-50, BO MK 1/20 10-50	5	TR 12510-20 ...
150	10	20	294208	294215	294222	294239	1,250	4,000	BO 12/20 10-50, BO MK 1/20 10-50	5	TR 15010-20 ...
200	10	20	294246	294253	294260	294277	950	3,000	BO 12/20 10-50, BO MK 1/20 10-50	5	TR 20010-20 ...



Polishing tools

Arbors

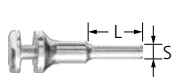

BO 6/6 3-10

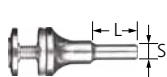

BO 8/10 6-20

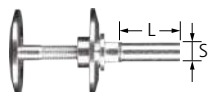

BO 12/20 10-50



BO MK 1/20 10-50

Arbors for felt wheels and cloth rings BO

Matching arbors for felt wheels and cloth rings.

Advantages:

- High economic efficiency as the tool can be changed quickly.

Ordering notes:

- Please complete the description with the desired type.

Suitable for centre hole dia. [mm]	S [mm]	L [mm]	Clamping width [mm]	EAN 4007220		Description
6	6	25	3-10	297650	1	BO 6/6 3-10
10	8	30	6-20	297667	1	BO 8/10 6-20
20	12	35	10-50	297674	1	BO 12/20 10-50
	-	-	10-50	297681	1	BO MK 1/20 10-50

You can find additional felt polishing tools in the following product families:



COMBICLICK:
CC-FR, page 18



COMBIDISC:
CD-FR, page 42



Short belts:
P-BA, page 51

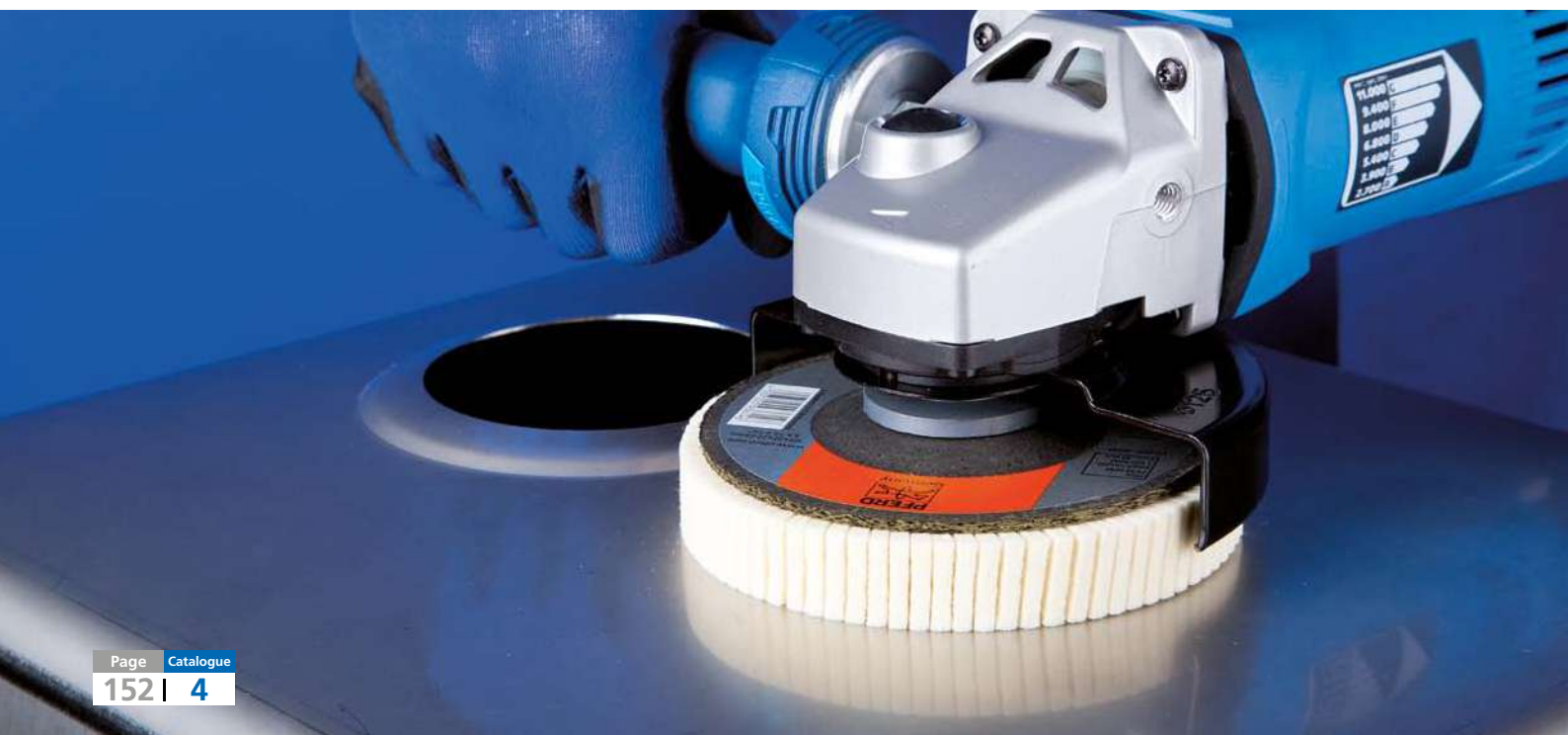

PFERD offers grinding pastes for use in extremely fine grinding work, such as when grinding in valve seats, shaft bearings and as a preparation for polishing with felt polishing tools and cloth rings.

PFERD offers five different polishing paste bars that are marked with different colours, which enables them to be easily assigned to the respective application task. You can find the key for the respective colours in the table below.

Advantages:

- High productivity.
- Quick results.
- Coordinated system.

Materials that can be worked:

- Can be used on nearly all materials.

Applications:

- Polishing
- Step-by-step fine grinding



Grinding pastes SFP

Oil-soluble grinding pastes with sharp-edged SiC grain.



Grit size	Contents [g]	EAN 4007220		Description
90	250	153963	1	SFP 90
150	250	153970	1	SFP 150
280	250	153987	1	SFP 280
360	250	153994	1	SFP 360
600	250	298664	1	SFP 600
800	250	154007	1	SFP 800

Polishing paste bars PP

Apart from being used with felt tools, polishing pastes are also used in combination with cloth rings for pre-polishing and high-gloss polishing. If the intention is to achieve very smooth surface finishes, use several or even all types successively.

Intended applications for the different types:

- ST (sisal cloth) = Coarse pre-polishing with PP 1, PP 2 or PP 3
- TH (hard cloth) = Pre-polishing with PP 1, PP 2 or PP 3
- TW (soft cloth) = High-gloss polishing with PP 4 or PP 5
- FL (flannel) = High-gloss polishing/buffing with PP 4 or PP 5

Polishing paste bars are available in a small pack and a bulk pack.

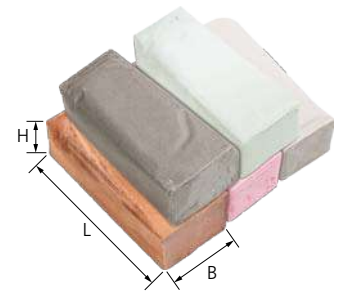

Type	Use for	Con-tents [g]	EAN 4007220	Colour	B [mm]	H [mm]	L [mm]		Description
Bulk pack									
pre-polishing	Steel + stainless steel (INOX)	1,100	294567	green	70	50	140	1	G-PP 1 VP STEELOX
	Aluminium + brass	1,300	294574	grey	70	50	140	1	G-PP 2 VP ALU
	Non-ferrous metals	1,150	294581	brown	70	50	140	1	G-PP 3 VP NON-FERROUS
high-gloss polishing	All metals	1,150	294598	pink	70	50	140	1	G-PP 4 HGP UNIVERSAL
	plastics	1,100	294604	beige	70	50	140	1	G-PP 5 HGP PLAST
Small pack									
pre-polishing	Steel + stainless steel (INOX)	108	955666	green	25	30	90	1	K-PP 1 VP STEELOX
	Aluminium + brass	142	955673	grey	25	30	90	1	K-PP 2 VP ALU
	Non-ferrous metals	111	955680	brown	25	30	90	1	K-PP 3 VP NON-FERROUS
high-gloss polishing	All metals	132	955697	pink	25	30	90	1	K-PP 4 HGP UNIVERSAL
	plastics	104	955703	beige	25	30	90	1	K-PP 5 HGP PLAST

Grinding oils and polishing pastes

Diamond polishing pastes

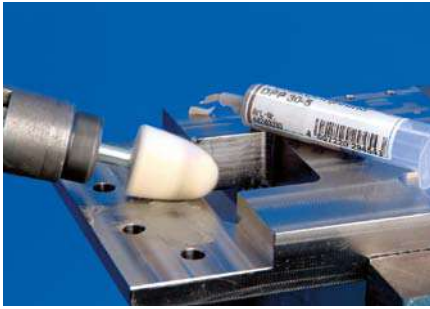

Diamond polishing pastes are used for work on very hard materials, such as tungsten carbide and hardened steels. They are used in combination with felt polishing elements or discs. Diamond polishing pastes can be diluted and dissolved with water and alcohol.

Diamond polishing pastes in the ECO type are a cheaper alternative.

Available grit sizes:

- 30 (coarse) = P 500
 - 15 (medium) = P 1200
 - 10 (medium-fine) = P 2000
 - 7 (fine) = P 3000
 - 3 (very fine) = P 5000
 - 1 (ultra-fine) = P 14000
- (P = Grit size according to ISO 6344)

Advantages:

- High productivity.
- Quick results.
- Precisely coordinated granulation rows.

Applications:

- Polishing
- Step-by-step fine grinding

Materials that can be worked:

- Can be used on almost all very hard materials, such as tungsten carbide and hardened steels.

Ordering notes:

- The grit sizes are specified in μm .
- Please complete the description with the desired contents.
- When ordering, please state the EAN or the full description.



Diamond polishing pastes DPP, Diamond polishing pastes type ECO DPP

Diamond polishing pastes guarantee quick and efficient work, particularly in tool- and mould-making.

Recommendations for use:

- When using diamond polishing pastes, use the coarse paste first.
- If extensive surface improvements are required, use several grit sizes one after another, each finer than the previous, cleaning well between pastes.
- When changing grit size, make sure that a new, clean abrasive support (e.g. felt point or felt wheel) is used.

Ordering notes:

- Please complete the description with the desired grit size.

Grit size [μm]	Contents [g]			Colour of sealing cap		Description
	5	20	10			
EAN 4007220						
DPP						
30	294543	535981	-	brown	1	DPP 30-...
15	294536	535998	-	blue	1	DPP 15-...
10	025468	025499	-	light blue	1	DPP 10-...
7	294505	536001	-	red	1	DPP 7-...
3	294499	536018	-	green	1	DPP 3-...
1	025451	025475	-	yellow	1	DPP 1-...
ECO DPP						
30	-	-	025550	brown	1	DPP ECO 30-...
15	-	-	025543	blue	1	DPP ECO 15-...
10	-	-	025536	light blue	1	DPP ECO 10-...
7	-	-	025529	red	1	DPP ECO 7-...
3	-	-	025512	green	1	DPP ECO 3-...
1	-	-	025505	yellow	1	DPP ECO 1-...

Special diluent for diamond polishing pastes PSP

The diluent is used to keep the lubricating layer between the support and the workpiece consistent during polishing work.

Recommendations for use:

- The diluent should be used extremely sparingly. Excessive use of the special diluent will wash out the diamond grit from the paste, thus diminishing polishing performance.



Contents [ml]	EAN 4007220		Description
125	294550	1	PSP 125

Grinding oils

Three types of grinding oil are supplied:

- **"Fe" for steel:** Offers protection against corrosion.
- **"NE" for non-ferrous metals and stainless steel (INOX):** Prevents unwelcome marks on the workpiece, particularly on stainless steel surfaces.
- **"ALU" for aluminium:** Prevents the grinding tool from clogging.

Advantages:

- Longer tool life.
- Lower temperature development due to lubricating and cooling effect.
- Less adherence of chips to the abrasive coating.
- Improved surface finish.

Applications:

- Polishing
- Step-by-step fine grinding

Ordering notes:

- The transportation of the aerosol cans by air, sea and rail is not possible.



4



Materials that can be worked:

- Can be used on nearly all materials.

Grinding oils

Grinding oils are used in applications with coated abrasive tools.



Use for	Contents [ml]	EAN 4007220		Description
Spray can				
steel	400	147597	1	410 Fe
non-ferrous metals, stainless steel (INOX)	400	147603	1	411 NE
aluminium	400	791332	1	412 ALU
Canister 1 l				
steel	1,000	294444	1	410/1 Fe
non-ferrous metals, stainless steel (INOX)	1,000	294451	1	411/1 NE
aluminium	1,000	791349	1	412/1 ALU
Canister 5 l				
steel	5,000	294468	1	410/5 Fe
non-ferrous metals, stainless steel (INOX)	5,000	294475	1	411/5 NE
aluminium	5,000	791356	1	412/5 ALU

Grinding oils and polishing pastes

Cleaner



The highly effective cleaners and maintenance products are practically applied to a very wide range of components.

Materials that can be worked:

- Can be used on nearly all materials.

Applications:

- Cleaning
- Preserving
- Protecting



Universal cleaner UC-S

Highly effective, universal workshop cleaner for cleaning and de-greasing components as a preparation for painting. Removes polishing paste residue, processing oils, corrosion-protection oils, light waxes and other types of contamination.

Advantages:

- Biodegradable surfactants.
- Short drying time.
- Non-combustible.
- Suitable for versatile use.

Recommendations for use:

- Spray, briefly leave on and wipe off with a suitable cloth.

Contents [ml]	EAN 4007220		Description
500	027349	1	UC-S 500



INOX SHINER IS-S maintenance product

Maintenance products for protecting and caring for stainless steel (INOX), aluminium, non-ferrous metals, glass and plastic. Removes dust, fingerprints, oil and light scale deposits.

Advantages:

- Leaves a dry, glossy protective film.
- Very easy to use.
- No cleaning marks.
- Suitable for versatile use.

Recommendations for use:

- Spray, apply evenly on the surface with a soft dry cloth or paper towel and wipe dry.
- Conduct a compatibility test beforehand on surfaces with a mirror finish.

Contents [ml]	EAN 4007220		Description
500	027332	1	INOX SHINER IS-S 500



VICTO GRAIN

Further information about the high-performance abrasive grain VICTOGRAIN as well as an overview of all respective products can be found on the following pages.

VICTOGRAIN products are some of the most effective grinding tools in the world.

PFERD's triangular, precision-formed abrasive grain achieves uniquely high abrasive performance.

The **VICTOGRAIN** abrasive grain triangles are identical in shape and size and their cutting edges are applied to the workpiece at the optimum angle, meaning the grain needs very little energy to penetrate the workpiece. As such, the user benefits from an efficient machining process with

- fast working,
- a long tool life,
- less heat build-up in the workpiece, and
- a lower power output required for the tool drive.

The **VICTOGRAIN** abrasive grain triangles are fixed to the substrate on one of their sides.

This means they are securely fixed in place and, together with their slim design, offer an extremely large chip space in order to further improve machining efficiency.

The structure of the triangular **VICTOGRAIN** has also been specially adapted to maximize results. The very small crystals inside the triangles ensure optimal wear characteristics as sharp cutting edges are always exposed, but only the minimum amount of abrasive grain/the triangle breaks off.

By combining all these properties together, users benefit from optimal, constant performance during cool grinding and an extremely long tool life together with consistent workpiece surface roughness.

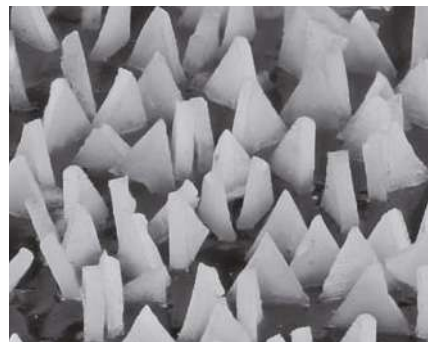

The **VICTOGRAIN** abrasive grain is optimally aligned

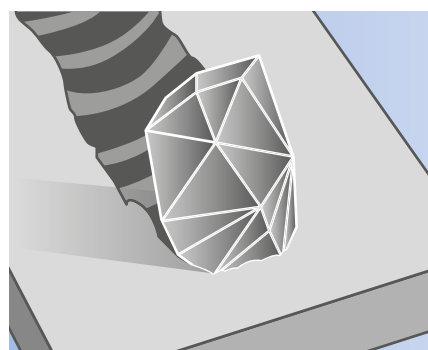

Conventional abrasive grain

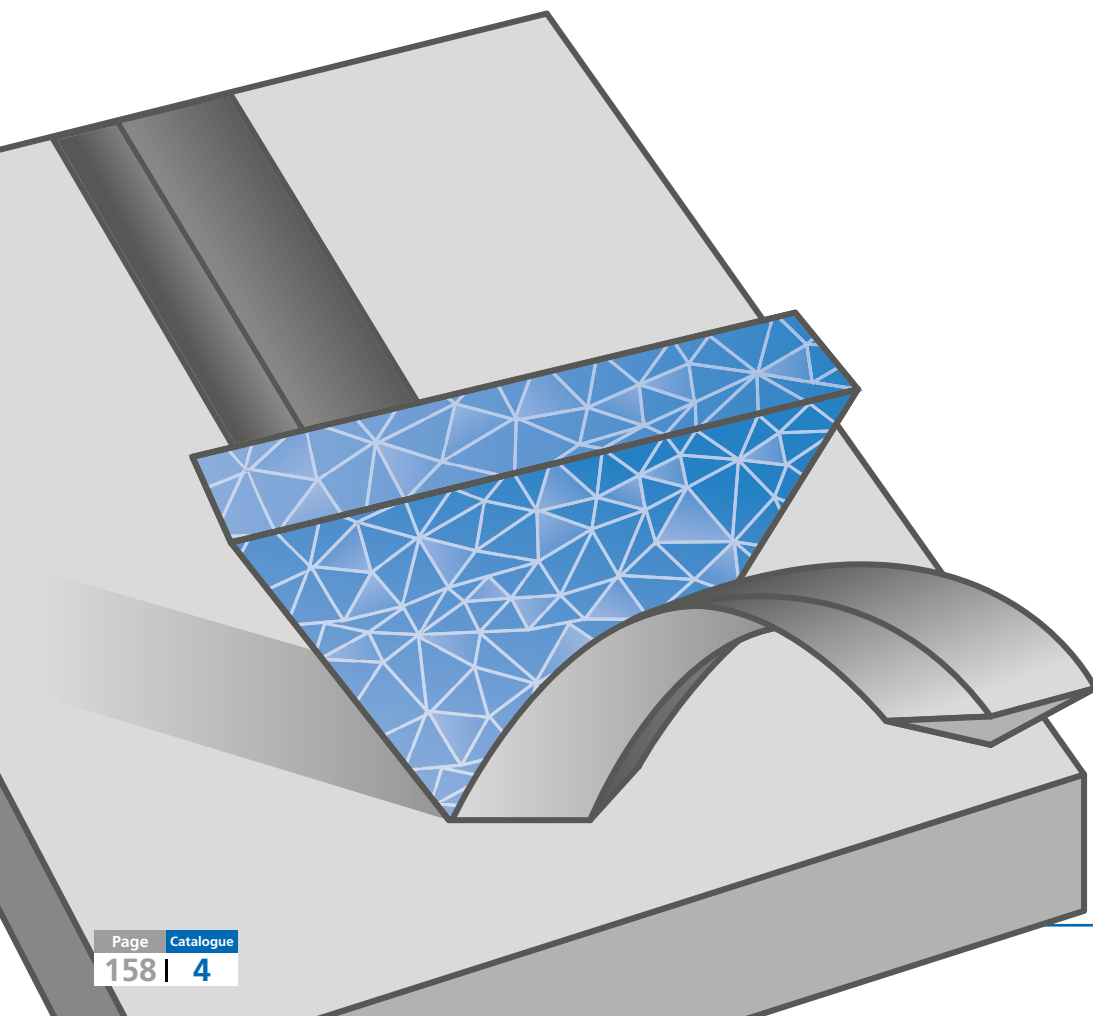

VICTOGRAIN abrasive grain

Here is an overview of all **VICTOGRAIN** products which can be found in catalogue section 4:

Picture	Description	Page
	COMBICLICK fibre discs VICTOGRAIN-COOL	15
	Fibre discs VICTOGRAIN-COOL	23
	COMBIDISC abrasive discs VICTOGRAIN-COOL	36
	COMBIDISC midget fibre discs VICTOGRAIN-COOL	36



Here is an overview of all **VICTOGRAIN** products which can be found in catalogue section 6:

Picture	Description	Page
	CC-GRIND grinding discs CC-GRIND-SOLID SGP STEEL	49
	CC-GRIND grinding discs CC-GRIND-SOLID SGP INOX	49
	CC-GRIND grinding discs CC-GRIND-FLEX SGP STEEL	50





Catalogue section 1

Files



Catalogue section 2

Milling tools



Catalogue section 3

Mounted points



Catalogue section 4

Fine grinding and polishing tools



Catalogue section 5

Diamond and CBN tools



Catalogue section 6

Cut-off wheels, flap discs and grinding wheels



Catalogue section 7

Cut-off wheels for stationary applications



Catalogue section 8

Industrial power brushes



Catalogue section 9

Tool drives

Printed in Germany.

Subject to technical modifications.

04/2019

831 104



4007220699751